



nowości

Uchwyty meblowe

Niniejszy katalog jest prezentacją nowych uchwytów. Wyraziste, nowoczesne kształty, styl zgodny ze światowymi trendami powodują, że wspaniale komponują się ze współczesnymi meblami.



Pokrycia galwaniczne:

G2	chrom połysk,
G4	patyna na miedzi,
G5	nikiel matowy,
G6	chrom matowy,
G8	efekt stali szlachetnej,
G30	miedź lakierowana,
G35	efekt starej cyny,

Powłoki lakierowane

TL2	efekt chromu mat.
------------	-------------------

Kolory wkładek plastikowych:

T10	czarny,
T37	niebieski,
T38	biały,
T39	czerwony,
T40	pomarańczowy,

(uchwyty ze stron 15, 16).

Wykończenia elementów:

D32	buk.
------------	------



*Uchwyty meblowe.
Nowości.*



C-764B nowy wymiar klasycznego produktu

G2 G5 G6 G8

wyrób	rozstaw otworów	szerokość	długość	wysokość
C-763	96	8	130	28
C-764B	128	8	162	28
C-769-320	320	8	354	28

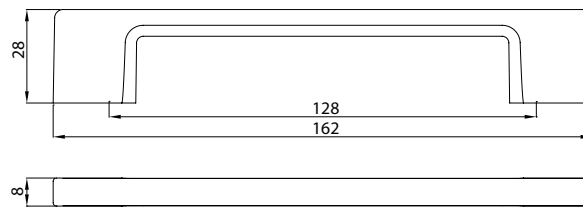



C-3278

wyrób	rozstaw otworów	szerokość	długość	wysokość	G2	G5	G6	G8
C-3274	128	10	192	31				
C-3278	256	10	318	31				

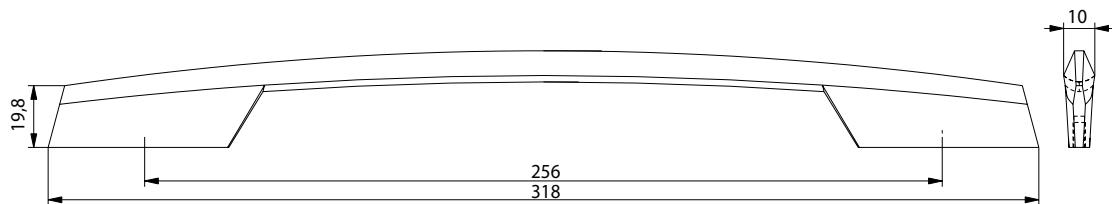

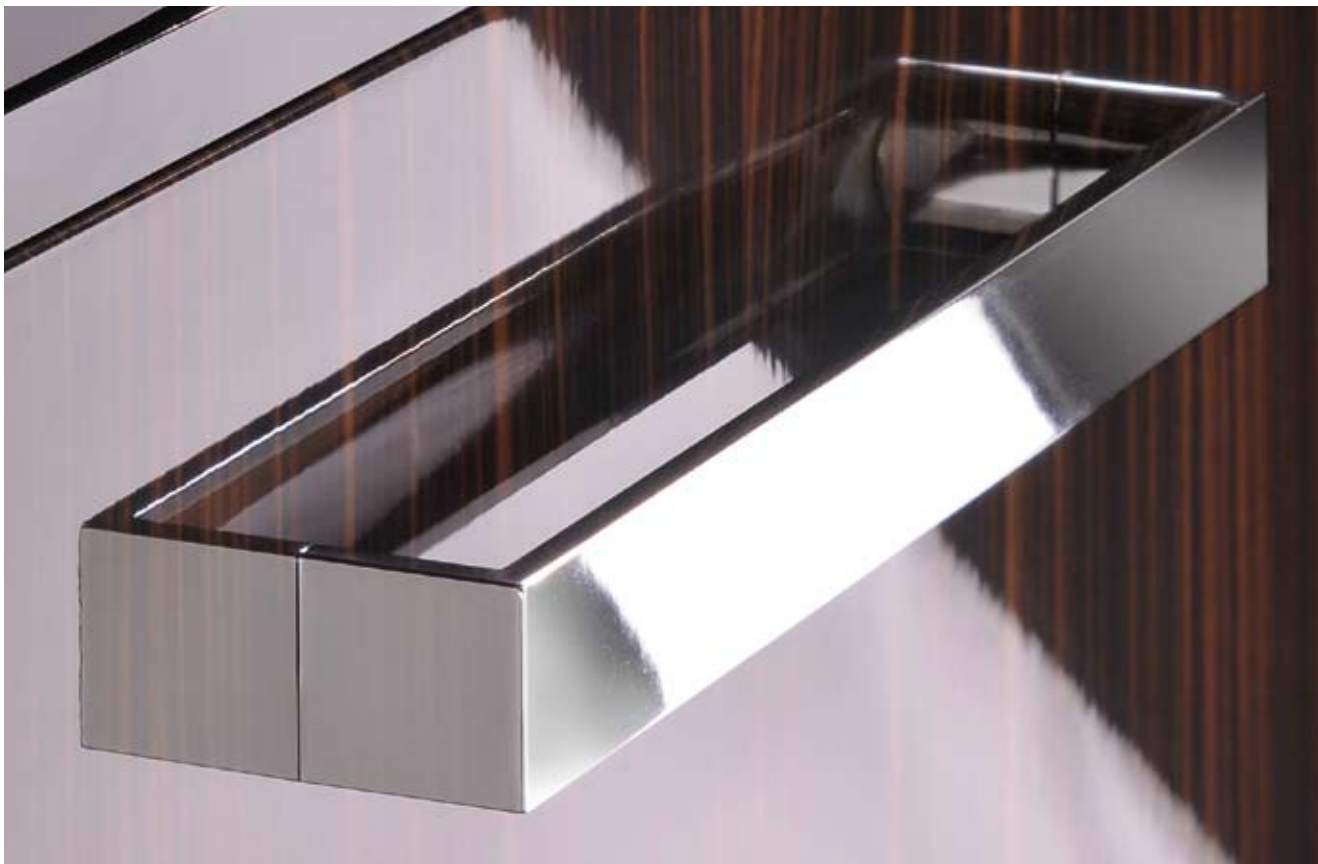

C-3318

wyrób	rozstaw otworów	szerokość	długość	wysokość
C-3314	128	31	135	31
C-3318	256	31	263	31

G2 G5 G6 G8

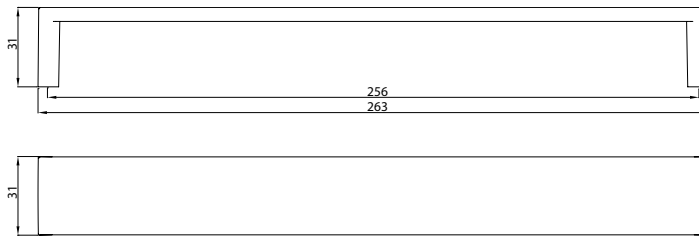



C-3335

G2 G5 G6 G8

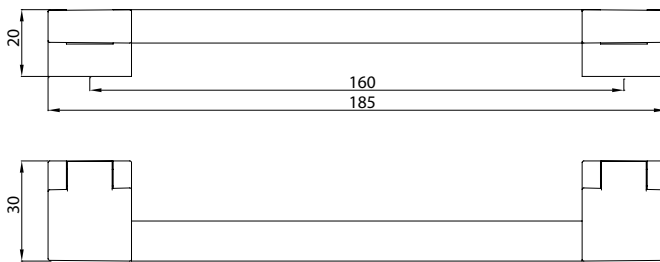

wyrób	rozstaw otworów	szerokość	długość	wysokość
C-3335	160	30	185	20
C-3336	192	30	217	20
C-3338	256	30	271	20
C-3339-320	320	30	345	20
C-3339-454	454	30	479	20

* Na życzenie klienta istnieje możliwość produkcji indywidualnych rozstawów.



C-3355

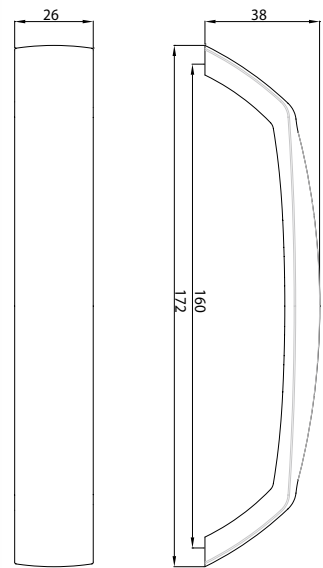

G2 G5 G6 G8



C-3374

G2 G5 G6 G8

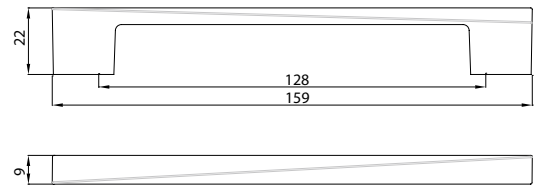



C-3384

G2 G5 G6 G8

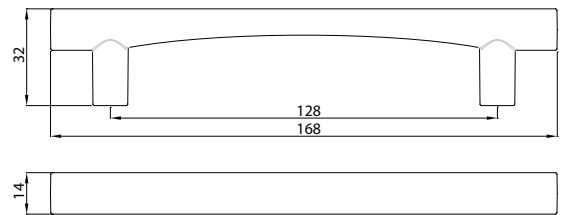





Z-5318

G2 G5 G6 G8

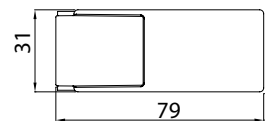
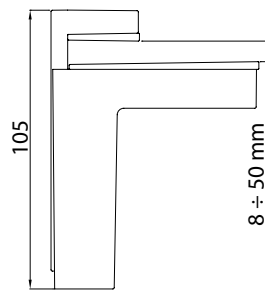



D-270

A-1374

G2 G5 G6 G8

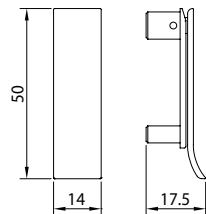

G2 G5 G6

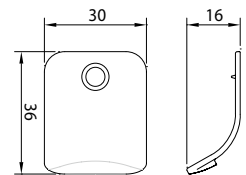



A-1405

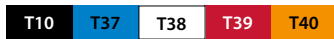
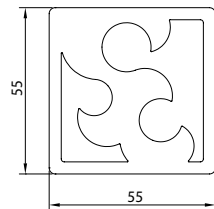
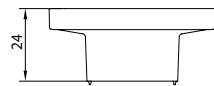

A-1415

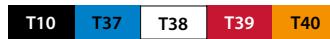
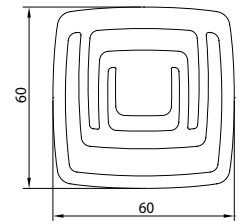
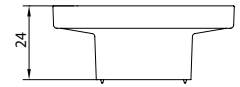



A-1425

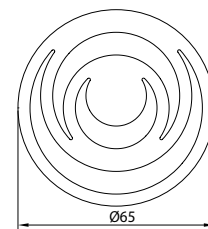
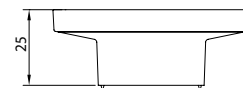

G2 G5 G6

T10 T37 T38 T39 T40



C-3243

G2 G5 G6 G8

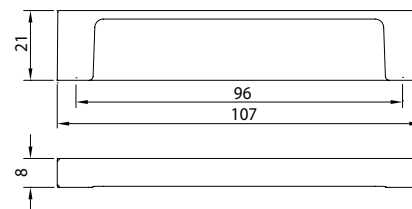



C-3125

G2 G5 G6

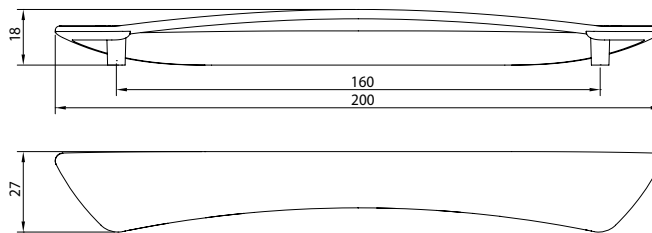



C-3159

wyrób	rozstaw otworów	szerokość	długość	wysokość
C-3154	128/192	13	230	30
C-3156	192/256	13	294	30
C-3158	256/320	13	358	30
C-3159-384	384/448	13	486	30
C-3159-620	620/684	13	722	30
C-3159-900	900/964	13	1002	30

* Na życzenie klienta istnieje możliwość produkcji indywidualnych rozstawów.

Dostępna kolorystyka

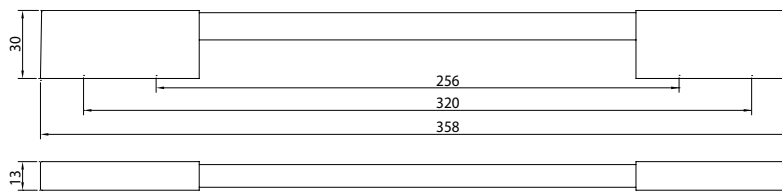



C-3137

G2 G5 G6 G8

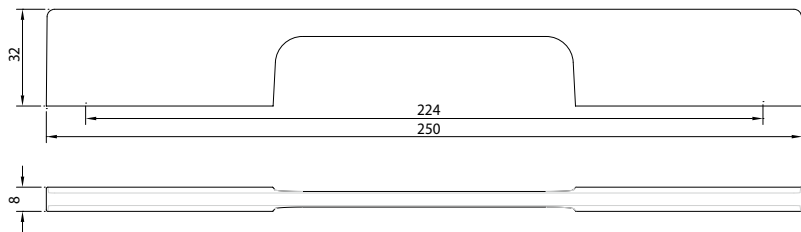

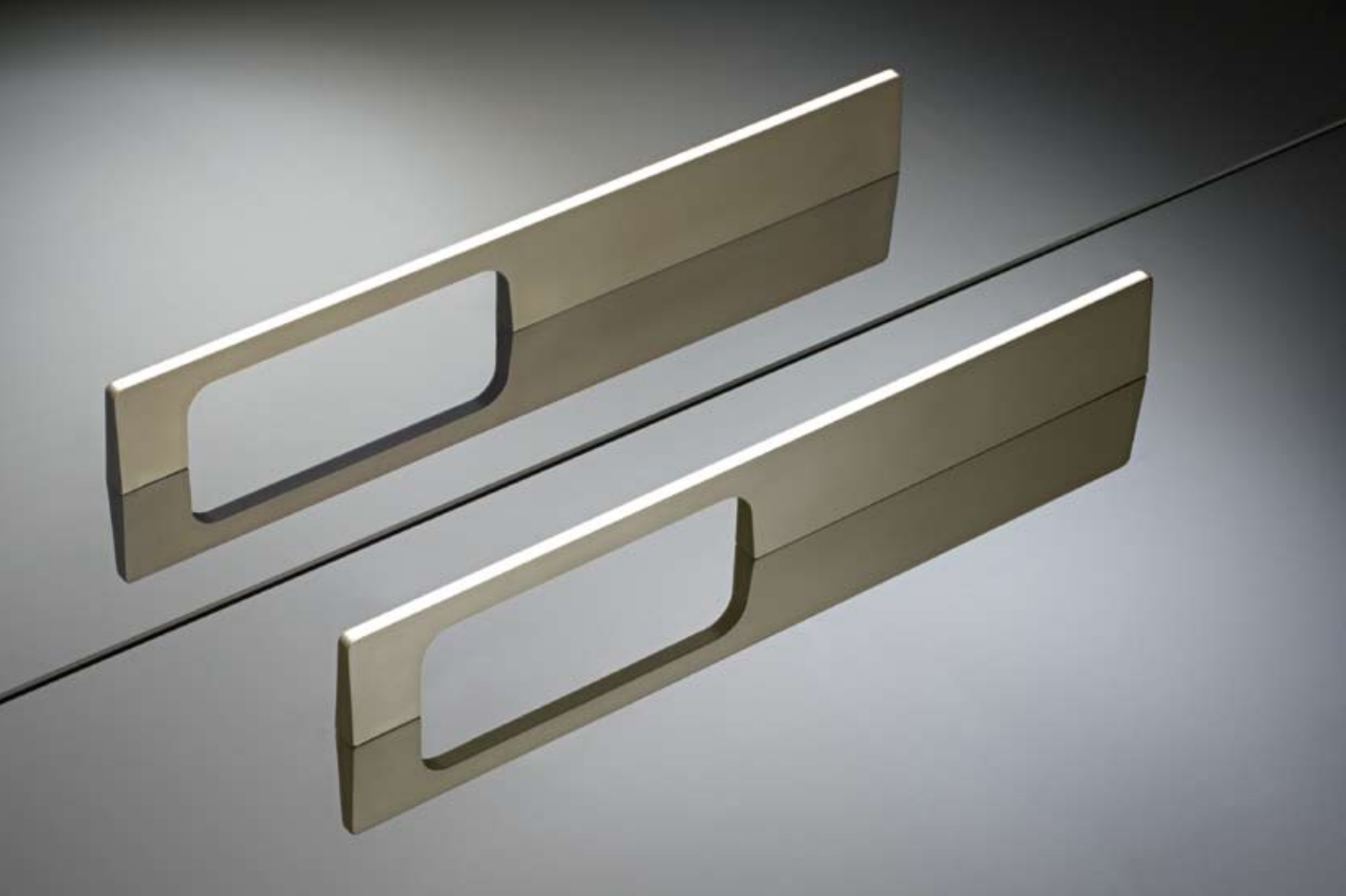

C-3147

G2 G5 G6 G8

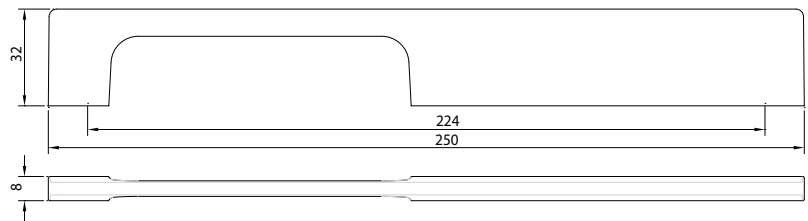



C-3164

G2 G5 G6 G8

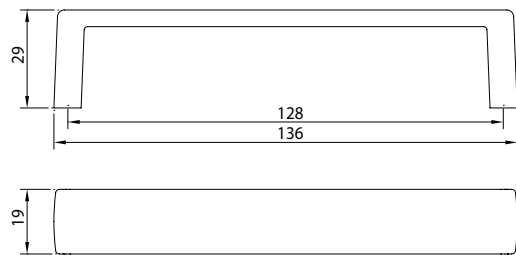



C-3193

TL2 — D32

* Na życzenie klienta istnieje możliwość produkcji indywidualnych rozstawów uchwyty oraz zastosowanie różnych gatunków drewna.

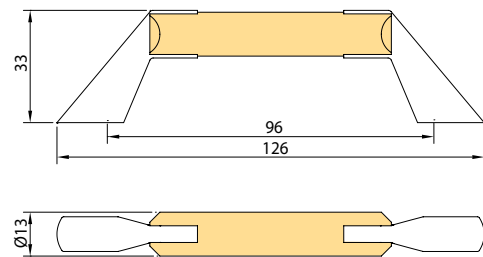



C-3184

TL2

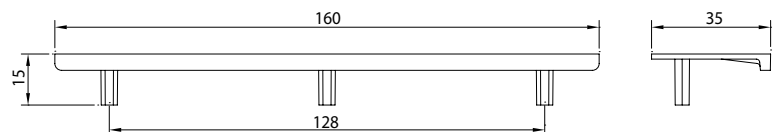



C-3232

G2 G5 G6 G8

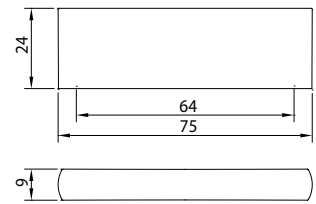



A-1434

G4 G35

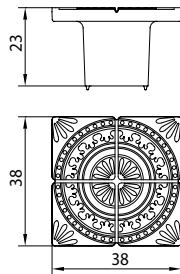

Z-5413

G4 G35

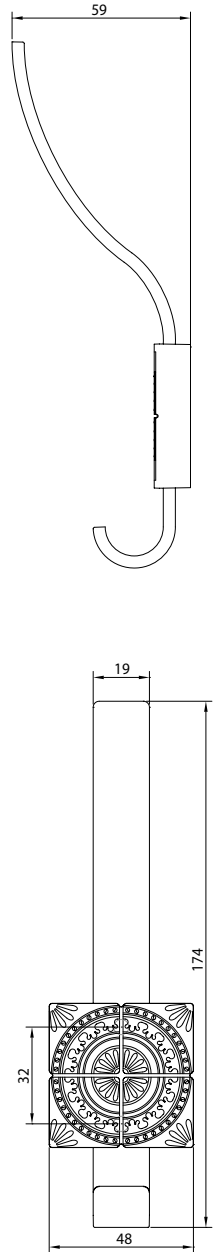



C-3264

G4 G35

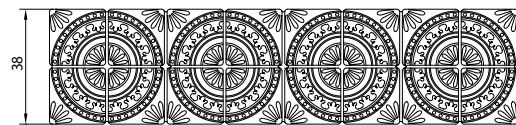
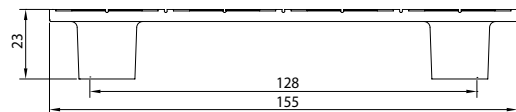



C-3283

wyrób	rozstaw otworów	szerokość	długość	wysokość
C-3283	96	18	121	30
C-3284	128	18	153	30
C-3286	192	18	217	30
C-3288	256	18	281	30
C-3289-320	320	18	345	30
C-3289-384	384	18	409	30
C-3289-480	480	18	505	30

* Na życzenie klienta istnieje możliwość produkcji indywidualnych rozstawów.

Dostępna kolorystyka

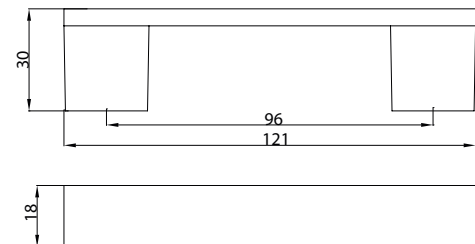



C-3298

TL2 G2

wyrób	rozstaw otworów	szerokość	długość	wysokość
C-3293	96	10	106	36
C-3294	128	10	138	36
C-3295	160	10	170	36
C-3296	192	10	202	36
C-3298	256	10	266	36
C-3299-320	320	10	330	36
C-3299-1028	1028	10	1038	36

* Na życzenie klienta istnieje możliwość produkcji indywidualnych rozstawów.

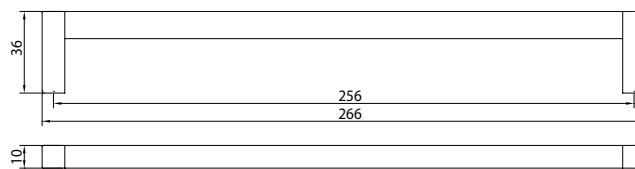



C-3308 Uchwyt z adapterem przeznaczony do drzwi składanych o grubości 18 mm

TL2 G2

wyrób	rozstaw otworów	szerokość	długość	wysokość
C-3303	96	10	106	36
C-3304	128	10	138	36
C-3305	160	10	170	36
C-3306	192	10	202	36
C-3308	256	10	266	36
C-3309-320	320	10	330	36
C-3309-1028	1028	10	1038	36

* Na życzenie klienta istnieje możliwość produkcji indywidualnych rozstawów.

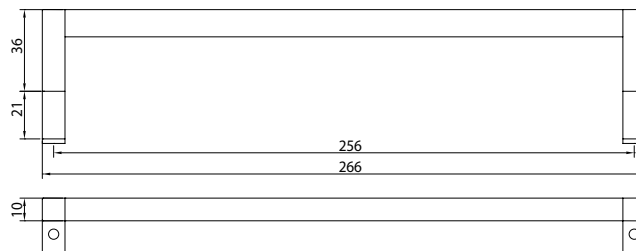



Z-5412 wieszak

G2 G5 G6

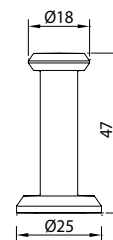



NOMET Sp. z o. o.

ul. Kanałowa 40/42
87-100 Toruń
Polska

Dział sprzedaży krajowej:

tel.: +48 56 61 98 111
tel./fax: +48 56 61 98 112
+48 56 61 98 113
fax: +48 56 61 98 117

Dział exportu:

tel.: +48 56 61 98 115
+48 56 61 98 153
+48 56 61 98 201
fax: +48 56 61 98 118

Dystrybutor:

www.nomet.pl

sprzedaz@nomet.pl

export@nomet.pl

Classic



**HARMONIA,
RÓWNOWAGA,
SPOKÓJ...**

Piękno, które pasuje do każdego wnętrza. Stonowana, spokojna kolorystyka i wysokiej jakości materiały mają wartość uniwersalną.

MOROCCO	Ø	H	P
A-082	17	28	100

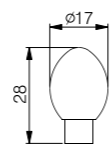

ZnAl G

BELIZE	W	H	L	P
A-096	19	30	40	100

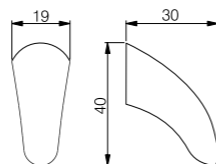

ZnAl G

ITALY	Ø	H	P
A-102	20	31	100

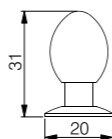

ZnAl G

CHINA	Ø	H	P
A-112	17	30	100

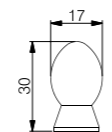

ZnAl G

TORINO	S	W	H	L	P
A-125	16	12	20	42	100

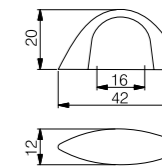

ZnAl G

MILAN	W	H	L	P
A-246	27	26	37	100

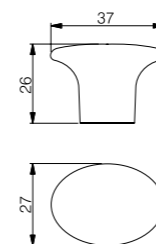

ZnAl G



NAPOLI	W	H	L	P
A-325	23	27	36	100

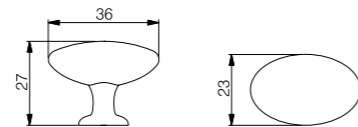

ZnAl G

PALERMO	W	H	L	P
A-335	20	24	39	100

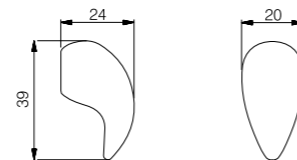

ZnAl G

Dieses Angebot gilt nicht für das Gebiet der Bundesrepublik Deutschland

VIENNA	Ø	H	P
A-391	12	22	100

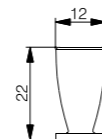

BRASS G

SYDNEY	Ø	H	P
A-400	24	20	100

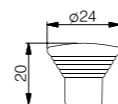

ZnAl G

MOSCOW	W	H	L	P
A-512	8	20	35	100

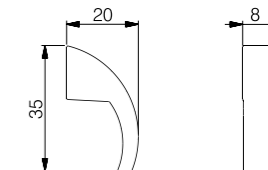

ZnAl G

ANKARA	Ø	H	P
A-544	25	28	100

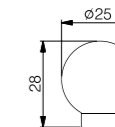

ZnAl G

MADRID	Ø	H	P
A-572	16	26	100

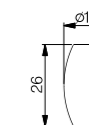

ZnAl G

BARCELONA	Ø	H	P
A-622	15	26	100



ZnAl G

WARSAW	W	H	L	P
A-783	20	18	33	100

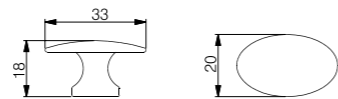

ZnAl G

MADEIRA	W	H	L	P
A-813	30	19	32	100

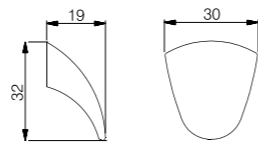

ZnAl G



TORONTO	Ø	H	P
A-823	31	29	100

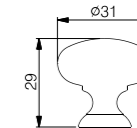

ZnAl G

HOKAIDO	Ø	H	P
A-832	18	23	100

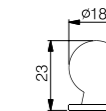

ZnAl G

NEW YORK	Ø	H	P
A-852	15	21	100

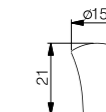

ZnAl G

DETROIT	Ø	H	P
A-914	35	27	100

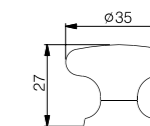

ZnAl G

CARTAGENA	Ø	H	P
A-995A	20	50	300

ZnAl G



NOWOŚĆ

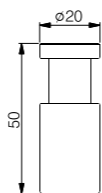

FARO	W	H	L	P
A-1037	20	26	70	100

ZnAl G

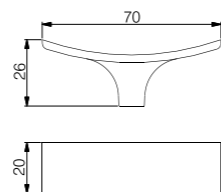

CHARLESTON	Ø	H	P
A-1063	24	27	100

ZnAl G

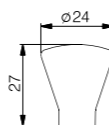

VICTORIA	W	H	L	P
A-1093	17	24	29	100

ZnAl G



JAWA	Ø	H	P
A-1101	19	16	100

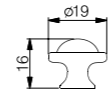

ZnAl G

HANOI	Ø	H	P
A-1113	20	29	100

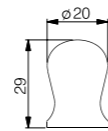

ZnAl G

PEKIN	Ø	H	P
A-1122	12	25	100

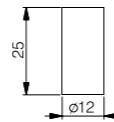

St G

MARRAKECH	Ø	H	P
A-1192	16	23	100

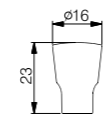

ZnAl G



LIBERC	Ø	H	P
A-1294	30	20	100

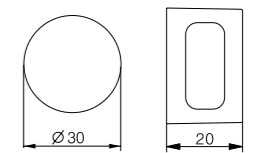

ZnAl G

BRNO	W	H	L	P
A-1324	16	27,5	28	50

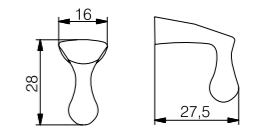

ZnAl G

NOWOŚĆ

NOWOŚĆ

ARGUS	S	W	H	L	P
A-077	16	21	25	43	100
C-313	96	16	29	133	50
C-314	128	16	29	165	100



A-077

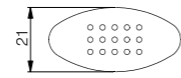
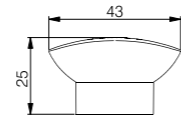

C-313

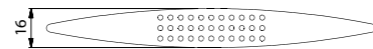
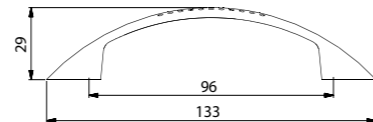

ZnAL G



ARGUS	S	W	H	L	P
A-1073		20	24	20	100
C-903	96	18	28	128	50
C-904	128	18	30	160	50



A-1073

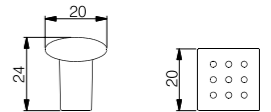

C-903

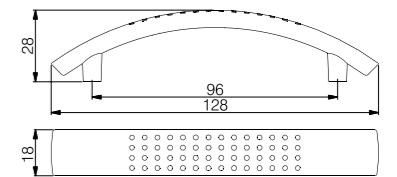

ZnAL G

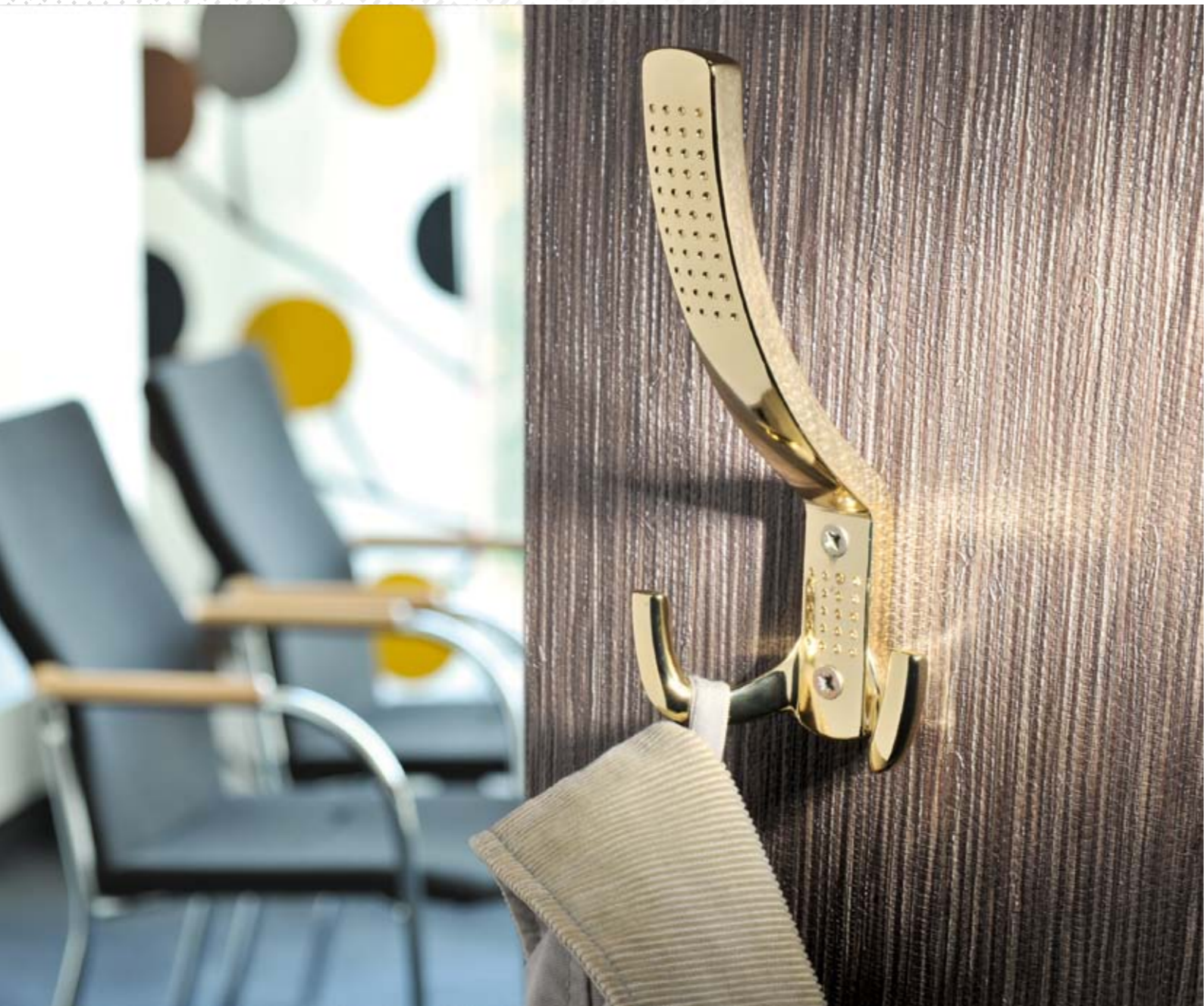

ARGUS	Ø	H	P
A-363	28	24	100
A-364	34	27	100

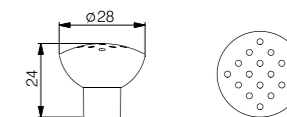

ZnAl G

ARGUS	Ø	H	P
A-1153	27	23	100

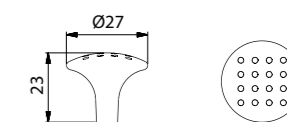

ZnAl G

ARGUS	S	W	H	L	P
Z-341	32	78	32	58	50
Z-355	32	78	65	148	100

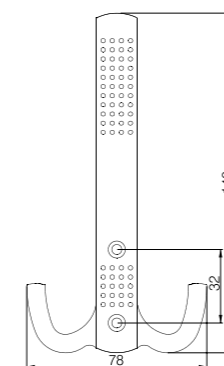
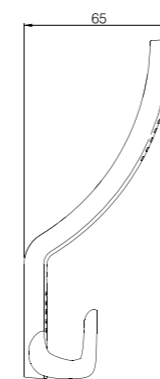

ZnAl G



Z-341

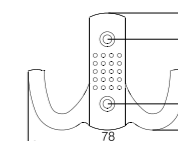
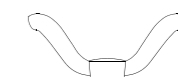

Z-355

ASTER	S	W	H	L	P
A-059	17	26	52	100	
C-432	64	17	25	98	100
C-434	128	17	30	162	50



A-059

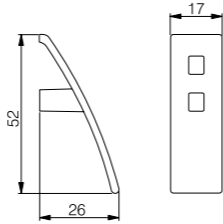

ZnAl G



C-434

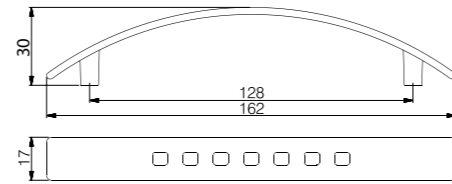

GEMINI	S	W	H	L	P
A-444	24	23	29	100	
C-1203	96	18	23	107	100
C-1204	128	18	23	139	100



A-444

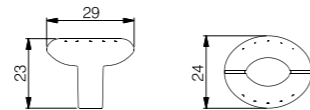

ZnAl G



C-1203

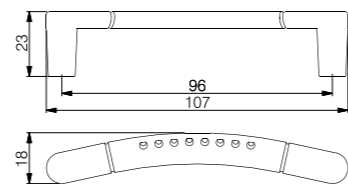

KOBRA	S	Ø	W	H	L	P
A-295		28			25	100
C-663	96		13	24	127	150
C-664	128		15	26	160	100



A-295

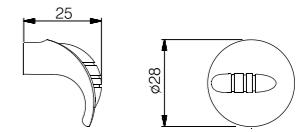

ZnAl G



C-663

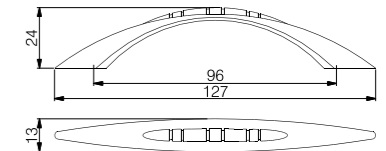

REGULUS	S	W	H	L	P
A-455		20	23	32	100
C-1083	96	13	25	105	100
C-1084	128	13	26	137	100



A-455

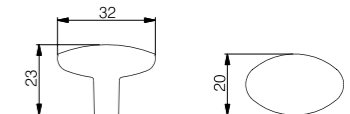

ZnAl G



C-1083

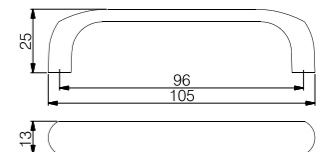



RIGEL	S	W	H	L	P
A-414	18	23	28	100	
C-1043	96	14	23	120	100
C-1044	128	14	23	153	50

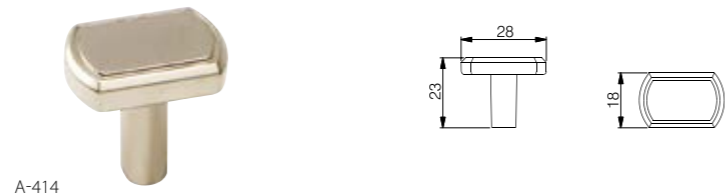

A-414



C-1043

ZnAl G

BERN	S	W	H	L	P
A-286	16	17	22	36	100
C-643	96	22	22	107	100
C-644	128	23	24	140	50

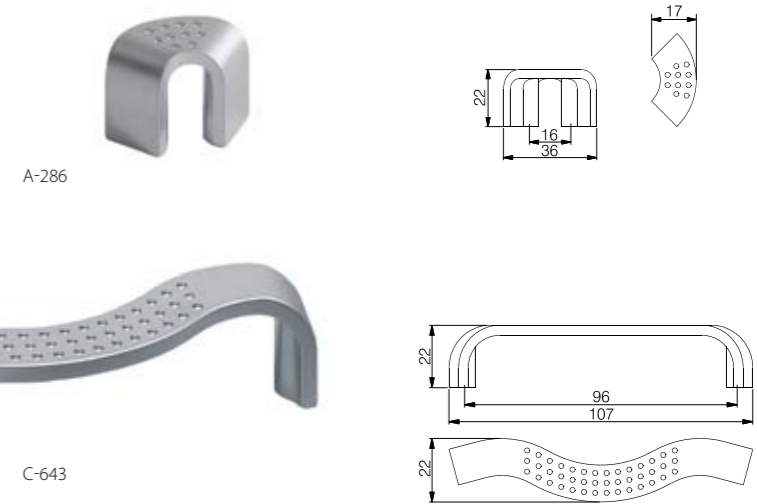

A-286

C-643

ZnAl G

NOWOŚĆ

DUBLIN	S	W	H	L	P
A-1342		15	25	34	100
C-3014	128	15	25	143	50
C-3015	160	15	25	175	50

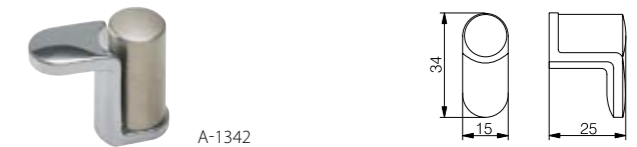

A-1342



C-3015

ZnAl G

SALEM

	S	Ø	W	H	L	P
A-424		27	24	23		100
C-1053	96		14	25	114	100
C-1054	128		14	25	152	100



A-424

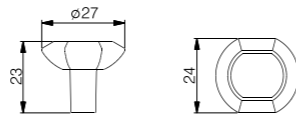

C-1053

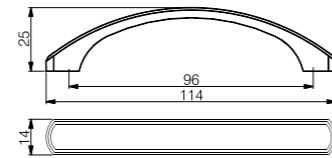

ZnAl

G

FORNAX

	S	W	H	L	P
A-472		20	23	32	100
C-1103	96	13	25	109	100
C-1104	128	13	27	141	100



A-472

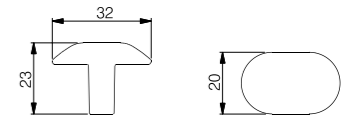

C-1104

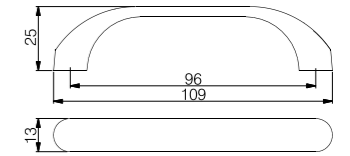

ZnAl

G

VIRGO

	S	Ø	W	H	L	P
A-464		28		23		100
C-1093	96		13	25	106	100
C-1094	128		13	27	138	100



A-464

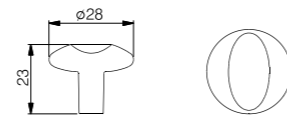

C-1093

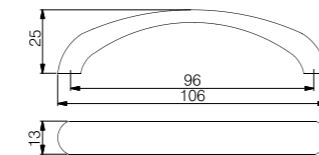

ZnAl

G

MUSCA

	S	W	H	L	P
A-484		24	23	29	100
C-1113	96	13	25	109	100



A-484

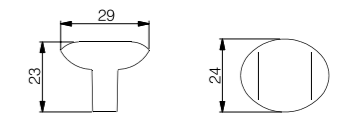

C-1113

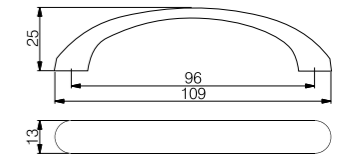

ZnAl

G

ROSARIO	S	W	H	L	P
C-2251	32	20	21	40	150

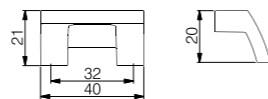

ZnAl G

MALLORCA	S	W	H	L	P
C-2011	32	19	19	40	150

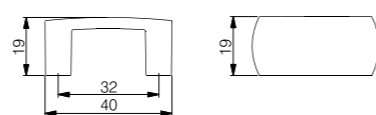

ZnAl G

BALTIC	S	W	H	L	P
C-451	32	20	20	41	200

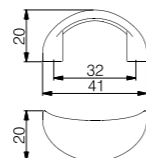

ZnAl G

BOMBAY	S	W	H	L	P
C-2161	32	8	28	40	200

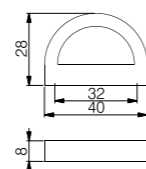

ZnAl G

CORONEL	S	W	H	L	P
C-2231	32	9	23	40	200

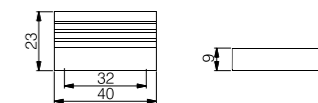

ZnAl G

REGINA	S	W	H	L	P
C-1611	32	8	23	55	100

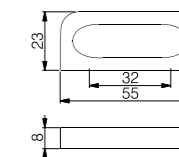

ZnAl G

CARACAS	S	W	H	L	P
C-2331	32	8	20	42	200

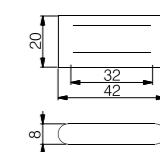

ZnAl G

HALLE	S	W	H	L	P
C-2271	32	8	22	42	200

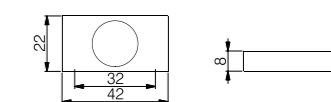

ZnAl G

Dieses Angebot gilt nicht für das Gebiet der Bundesrepublik Deutschland



LUPUS	S	W	H	L	P
C-1941	32	11	27	43	150

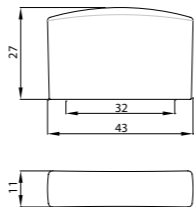

ZnAl G

DRACO	S	W	H	L	P
C-2481	32	26	24	54	200

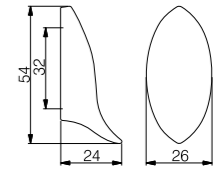

Dieses Angebot gilt nicht für das Gebiet der Bundesrepublik Deutschland

ZnAl G

AFRICA	S	W	H	L	P
C-2631	32	9	25	58	100

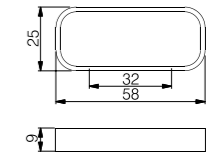

ZnAl G

ASPEN	S	W	H	L	P
C-2661	32	17	18	62	250

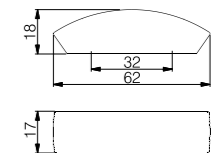

ZnAl G

MISSOURI	S	W	H	L	P
C-2452	64	19	23	83	100

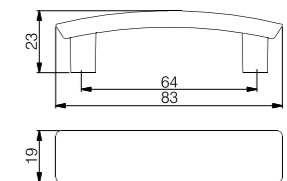

ZnAl G



RAVENA	S	W	H	L	P
C-601	32	31	27	40	150

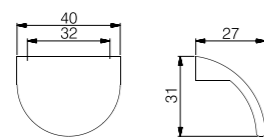

ZnAl G

VELA	S	Ø	H	P
C-1601	32	44	27	100

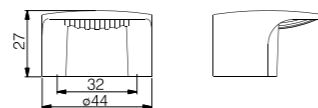

ZnAl G

NATAL	S	W	H	L	P
C-2301	32	23	50,5	45	250

Dieses Angebot gilt nicht für das Gebiet der Bundesrepublik Deutschland

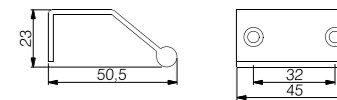
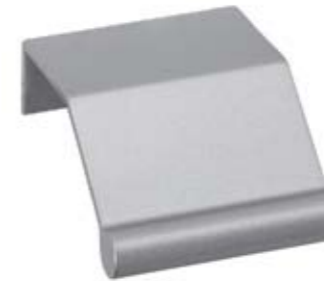

ZnAl G

SANTANA	S	W	H	L	P
C-2281	32	20	48	45	250

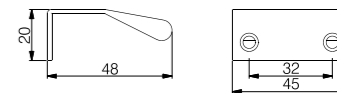

ZnAl G

ETNA	S	W	H	L	P
C-2431	32	18	20	78	200

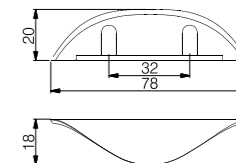

ZnAl G

PLYMOUTH	S	W	H	L	P
C-2701	32	14	46	44	50

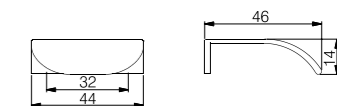

ZnAl G



KENYA	S	W	H	L	P
C-2642	64	34	43	108	50
C-2652	64	25	39	108	100

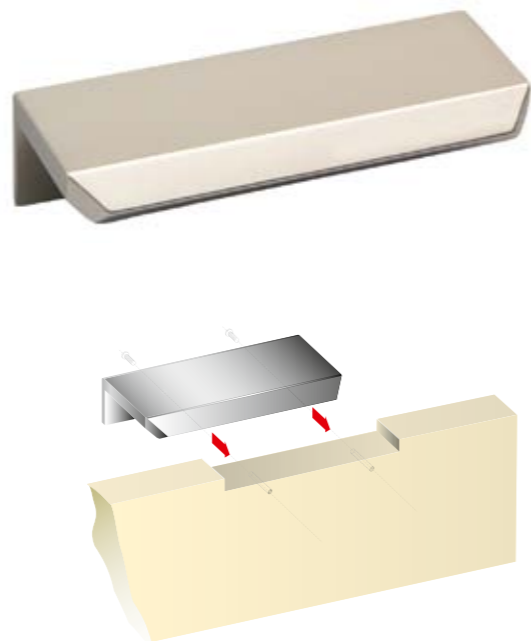
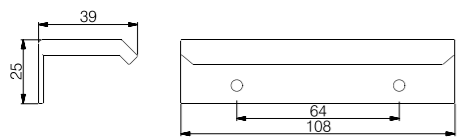

ZnAl G



PASTO	S	W	H	L	P
C-961	32	18	19	48	150
C-962	64	21	20	102	100

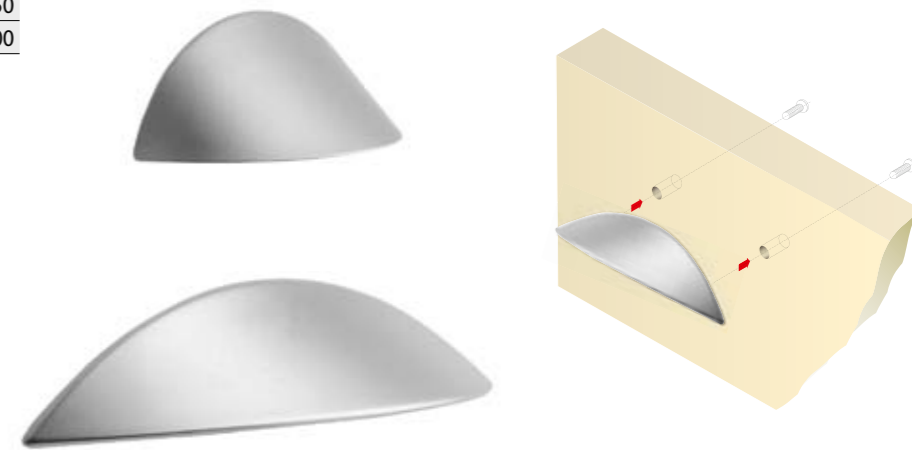
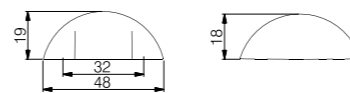

ZnAl G

MANILA	S	W	H	L	P
D-221	32	40	8	40	100

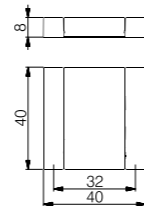

ZnAl G

SEOUL	S	W	H	L	P
D-230		50	9	22	100
D-231	32	50	9	50	100
D-232	64	50	9	80	50

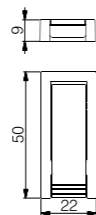

ZnAl G

EARTH	W	H	L	P
D-240	14	12	52	200

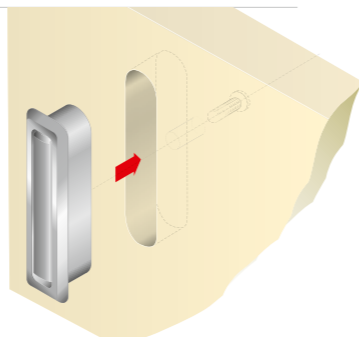
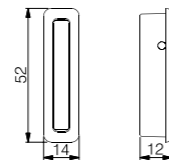

ZnAl G

WELLINGTON	S	W	H	L	P
D-250	32	40	8	46	100

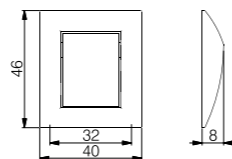

ZnAl G

CANBERRA	W	H	L	P
D-260	17	15	50	200

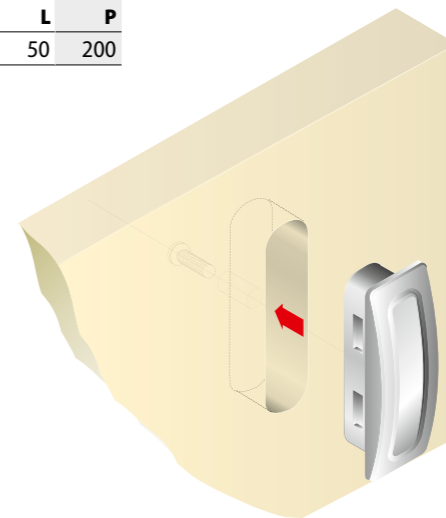
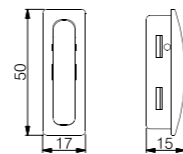

ZnAl G

NOWOŚĆ

NARVIK	W	H	L	P
D-270	14	17,5	50	100

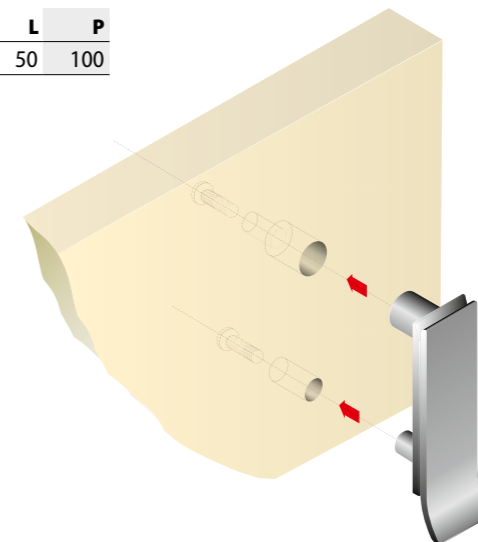
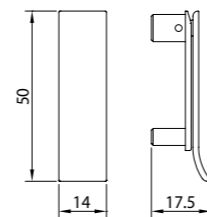

ZnAl G



RIO GRANDE	S	W	H	L	P
C-2243	96	16	23	110	100

ZnAl G

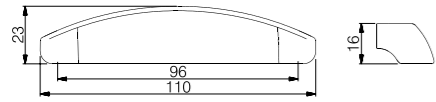
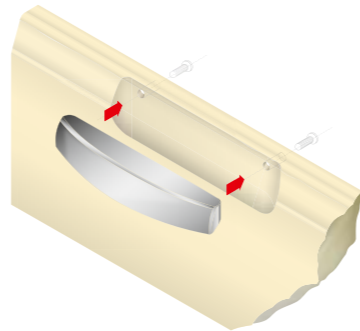

MEDELIN	S	W	H	L	P
C-2343	96	16	18	120	100

ZnAl G

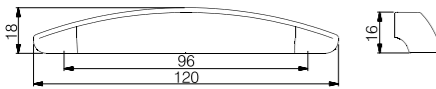
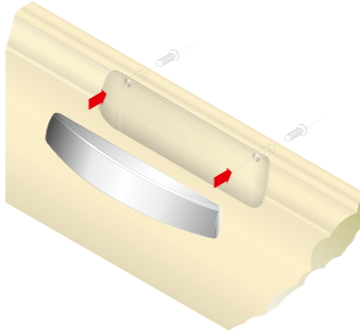

SAMOA	S	W	H	L	P
C-2003	96	13	13	125	100

ZnAl G

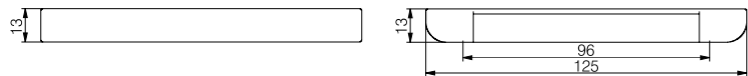
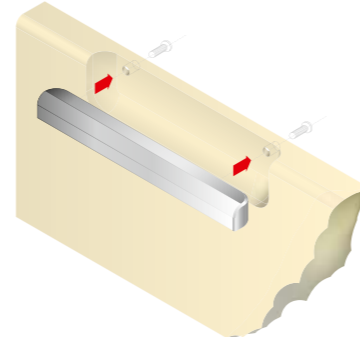

ENGLAND	S	W	H	L	P
C-2683	96	12	21	108	100

ZnAl G

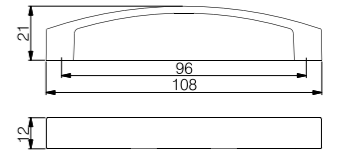

NOWOŚĆ

ILLINOIS	S	W	L	H	P
C-3243	96	8	107	21	50

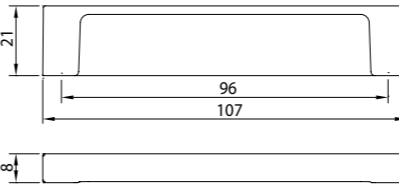

ZnAl G

ARGENTINA	S	W	H	L	P
C-2593	96	17	19	106	50

ZnAl G

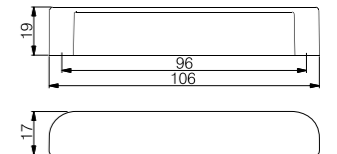

Dieses Angebot gilt nicht für das Gebiet der Bundesrepublik Deutschland

MALTA	S	W	H	L	P
C-068	80	8	22	92	200

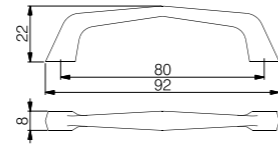

ZnAl G

PANAMA	S	W	H	L	P
C-144	128	11	25	158	100

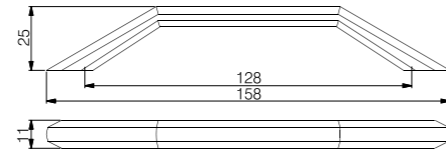

ZnAl G

NORWAY	S	W	H	L	P
C-133	96	10	23	146	100

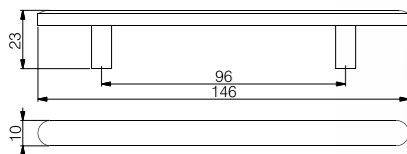

ZnAl G



MONACO	S	W	H	L	P
C-073	96	14	21	106	150
C-074	128	19	23	141	100
C-074-2	128	21	26	173	50

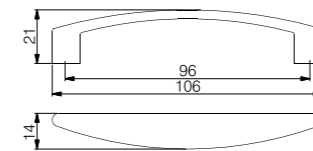

ZnAl G



C-073



C-074



C-074-2

GEORGIA	S	W	H	L	P
C-172	64	9	26	90	150
C-173	96	10	28	126	100
C-174	128	10	30	157	100



C-172

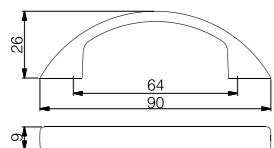

C-174

ZnAl G

COLORADO	S	W	H	L	P
C-484	128	16	29	165	100

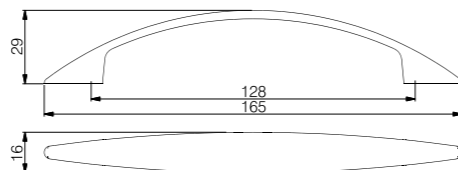

ZnAl G

MONTANA	S	W	H	L	P
C-723	96	11	21	120	150

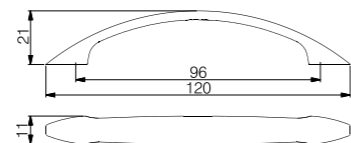

ZnAl G

OSLO	S	W	H	L	P
C-753	96	20	28	117	100
C-754	128	20	28	151	100

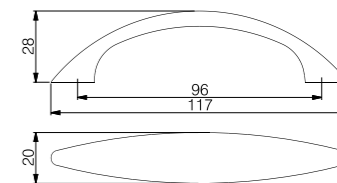

ZnAl G



HUDSON	S	W	H	L	P
C-242	64	10	33	79	100

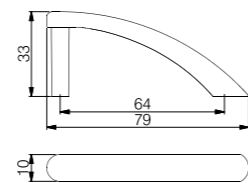

ZnAl G

VIRGINIA	S	W	H	L	P
C-633	96	13	30	110	100

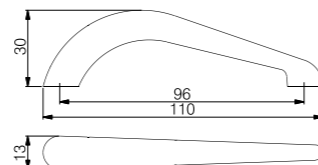

ZnAl G

BOLTON	S	Ø	H	L	P
C-442	64	8	27	72	100
C-443	96	8	27	104	100
C-444	128	8	27	136	100
C-445	160	8	27	168	100

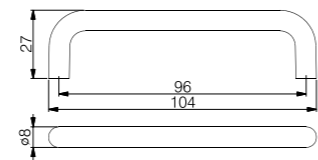

ZnAl G

ALABAMA	S	Ø	H	L	P
C-334	128	10	28	157	50

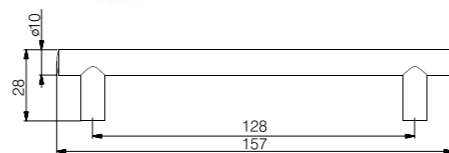

ZnAl G



NOWOŚĆ

IRELAND	S	W	H	L	P
C-3384	128	14	32	167	50

ZnAl G

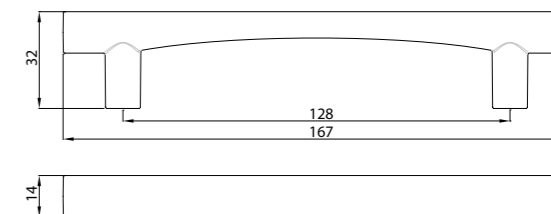



ARCO	S	W	H	L	P
C-622	64	10	24	81	200
C-623	96	10	25	115	150
C-624	128	11	28	160	100

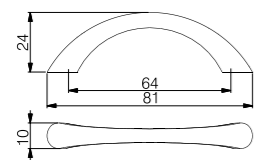

ZnAl G



C-622

C-623

C-624

CALIFORNIA	S	W	H	L	P
C-541	32	19	20	51	150
C-202	64	19	30	82	100
C-203	96	19	30	120	100

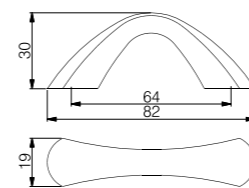

ZnAl G



C-541

C-202

C-203

LA PAZ	S	W	H	L	P
C-712	64	13	18	86	150
C-713	96	15	24	129	100
C-714	128	15	25	158	100



C-712



C-713



C-714

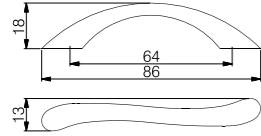

ZnAl G

BALTIMORE	S	W	H	L	P
C-943	96	10	28	118	100
C-944	128	11	29	151	100



ZnAl G

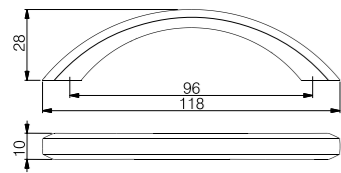

LYRA	S	Ø	H	L	P
C-953	96	10	25	117	100
C-014	128	10	30	149	100
C-016	192	10	30	223	50
C-1495	160	10	32,5	221	100



C-953

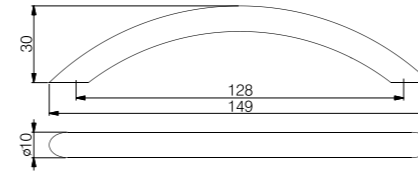

C-014

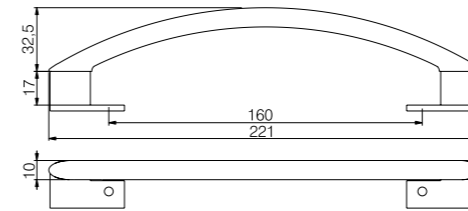

C-1495

*uchwyt z adapterem do płyty meblowej 16 mm
handle with adapter for furniture plate 16 mm
ручка с адаптерами 16 мм

ZnAl G

OLIVIA	S	W	H	L	P
C-503	96	12	24	127	150
C-504	128	13	24	163.5	100



ZnAl G

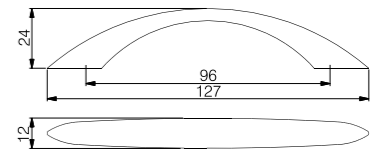

FLORIDA	S	W	H	L	P
C-562	64	20	25	92	100

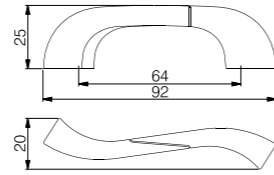

ZnAl G

PAROS	S	W	H	L	P
C-653	96	16	23	106	100

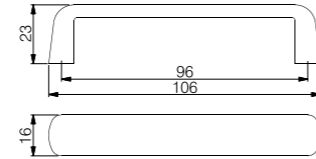

ZnAl G

BRAGA	S	W	H	L	P
C-673	96	14	27	108	100
C-674	128	18	28	140	100

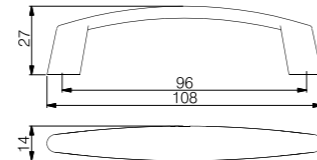

ZnAl G

DURBAN	S	W	H	L	P
C-744	128	13	28	141	100

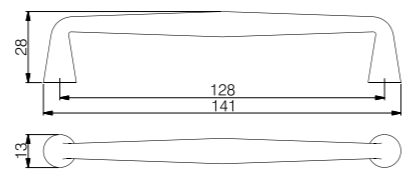

ZnAl G

CANTON	S	W	H	L	P
C-1223	96	9	28	117	150

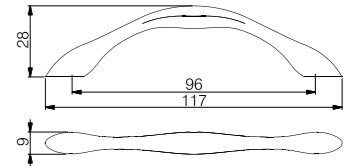

ZnAl G

ATLANTA	S	W	H	L	P
C-1258	80	17	30	110	100
C-1259	40	10	18	68	200

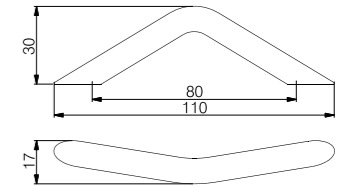

ZnAl G

NORFOLK	S	W	H	L	P
C-1323	96	12	25	139	100
C-1324	128	12	27	172	50

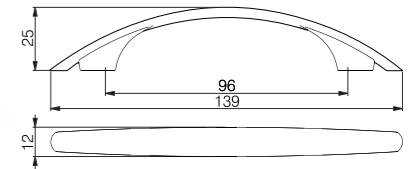

ZnAl G

CAMDEN	S	W	H	L	P
C-1363	96	11	25	121	100
C-1364	128	12	27	160	100

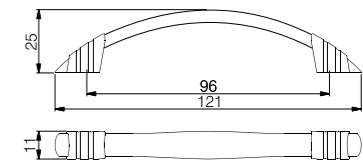

ZnAl G



DALLAS	S	W	H	L	P
C-1373	96	12	29	130	100
C-1374	128	13	30	166	100

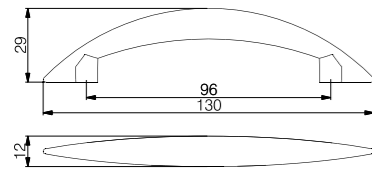

ZnAl G



C-1373

C-1374

LIMA	S	W	H	L	P
C-1413	96	20	27	108	100
C-1414	128	25	27	142	100

ZnAl G

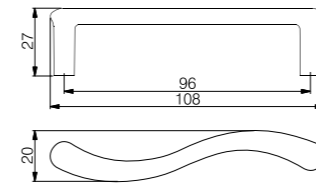

C-1413

C-1414

PUERTO RICO	S	W	H	L	P
C-1423	96	14	26	136	100

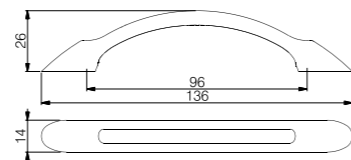

ZnAl G

FOSTER	S	W	H	L	P
C-1433	96	12	24	120	100
C-1434	128	14	25	154	100

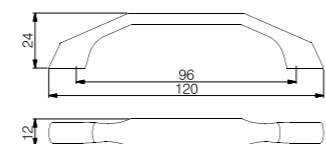

ZnAl G

GARI	S	W	H	L	P
C-1624	128	24	27	135	50
C-1625	160	24	27	167	50

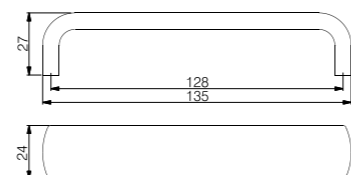

ZnAl G

IBIZA	S	W	H	L	P
C-1644	128	20	28	166	50
C-1645	160	22	28	202	50

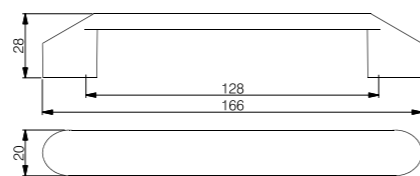

ZnAl G



ANDORA	S	W	H	L	P
C-1654	128	19	27	160	50
C-1655	160	20	28	194	100

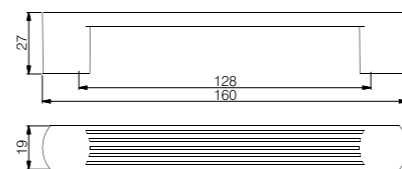

C-1655

ZnAl G

KAMPALA	S	Ø	H	L	P
C-1736	192	12	32	270	100

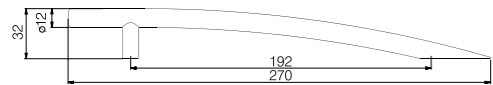

ZnAl G



MALAGA	S	W	H	L	P
C-2203	96	21	23	104	100

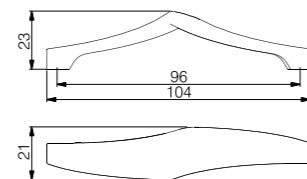

ZnAl G

ANTIGUA	S	W	H	L	P
C-2384	128	21	28	138	50

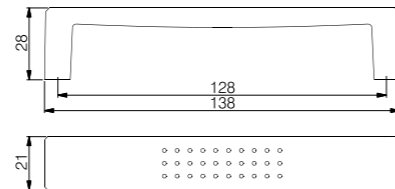

ZnAl G



ORINOCO	S	W	H	L	P
C-2421	32	10	26	50	150
*C-2424	128	11	28	145	50
C-2429-256	256	11	28	273	150

ZnAl G



C-2421

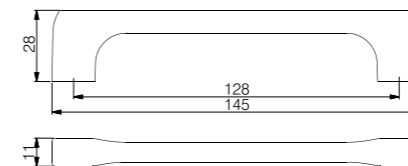

C-2424



C-2429-256

*Dieses Angebot gilt nicht für das Gebiet der Bundesrepublik Deutschland

INDUS	S	W	H	L	P
C-2464	128	13	30	144	50

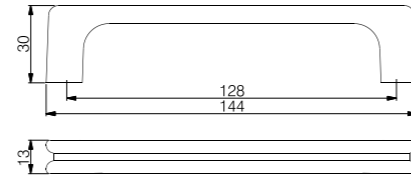

ZnAl G

ERIE	S	W	H	L	P
C-2473	96	13	30	106	100

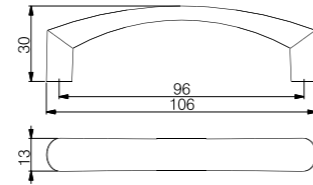

ZnAl G

MOUNTAIN	S	W	H	L	P
C-2491	32	13	24	44	100
C-2494	128	13	27	152	100
C-2496	192	14	30	229	50



C-2491

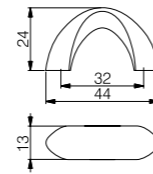

ZnAl G



C-2496

TONGA	S	W	H	L	P
C-2712	64	11	21	75	50
C-2713	96	13	25	109	50
C-2714	128	14	28	142	50



C-2712

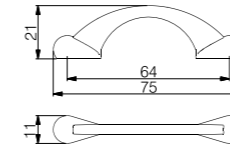

C-2714

ZnAl G

NOWOŚĆ

BRISTOL	S	W	H	L	P
C-2871	32	9	22	44	50
C-2872	64	9	25	86	50
C-2873	96	9	26	134	50
C-2874	128	9	27	176	50



C-2871

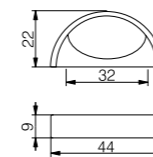

C-2874

ZnAl G

NOWOŚĆ

NORWICH	S	W	H	L	P
C-2904	128	10	26	141	50

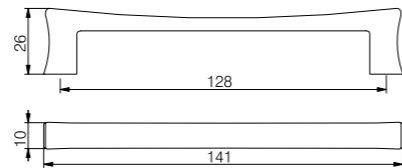

ZnAl G

NOWOŚĆ

LIVERPOOL	S	W	H	L	P
C-2974	128	15	28	152	50

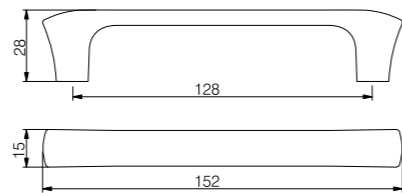

ZnAl G



NOWOŚĆ

LONDON	S	W	H	L	P
C-2984	128	26	35	136	50

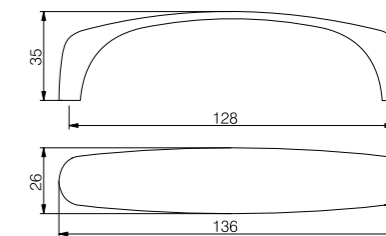

ZnAl G

BIRMA	S	W	H	L	P
C-3021	32	23	27	57	50

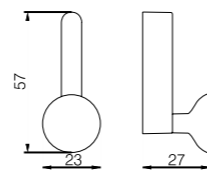

ZnAl G

NOWOŚĆ

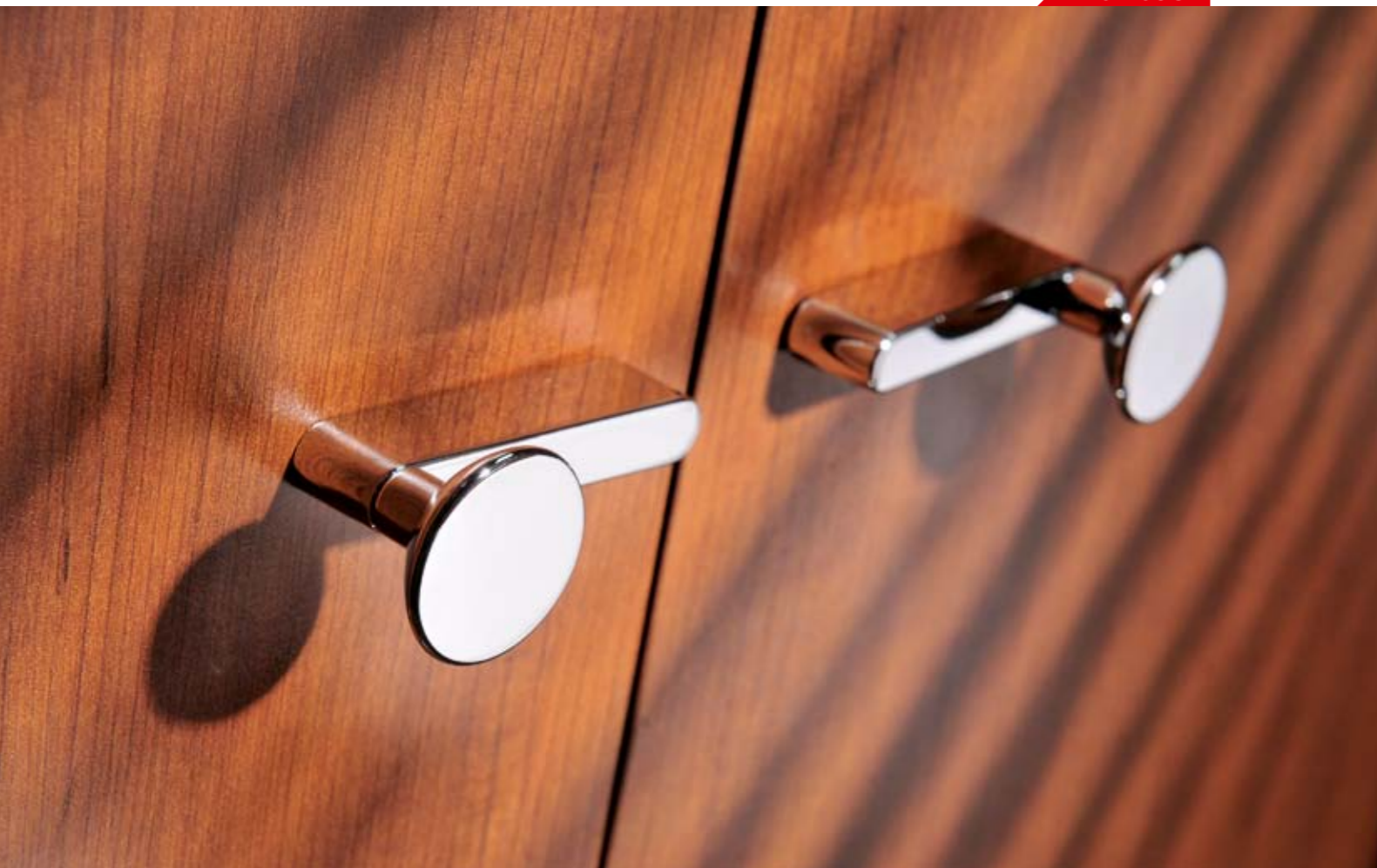

NOWOŚĆ

PORTO	S	W	H	L	P
C-3074	128	15	26	136	100
C-3076	192	19	29	202	50

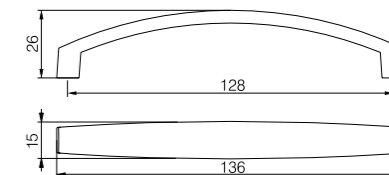

ZnAl G



NEVADA	S	W	H	L	P
C-324	128	24	29	169	50

ZnAl G

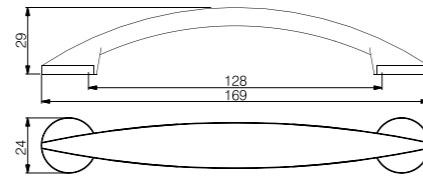

DAKOTA	S	W	H	L	P
C-405	160	31	29	200	50

ZnAl G

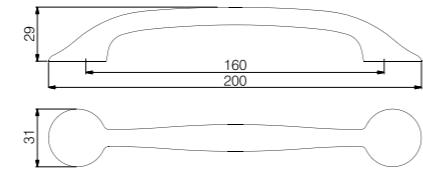

CYPRUS	S	W	H	L	P
C-495	160	25	30	185	50

ZnAl G

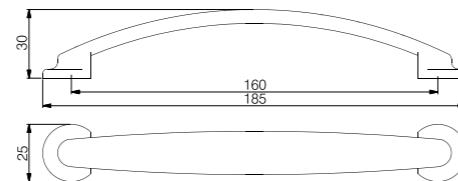

FIJI	S	W	H	L	P
C-1923	96	14	26	115	100

ZnAl G

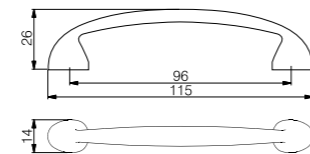

PADOVA	S	W	H	L	P
C-613	96	13	20	116	150
C-614	128	18	27	146	100

ZnAl G

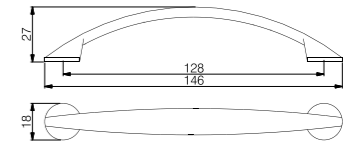

HOLMAR	S	W	H	L	P
C-1544	128	25	28	156	50

ZnAl G

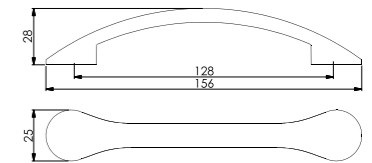

CAMPOS	S	W	H	L	P
C-1564	128	22	28	175	50

ZnAl G

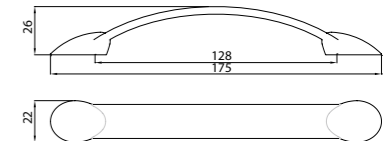

BERGEN	S	W	H	L	P
C-1634	128	18	30	186	50
C-1635	160	20	32	222	50

ZnAl G

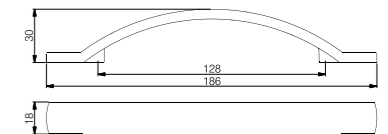

LAHTI	S	W	H	L	P
C-2044	128	11	33	168	50

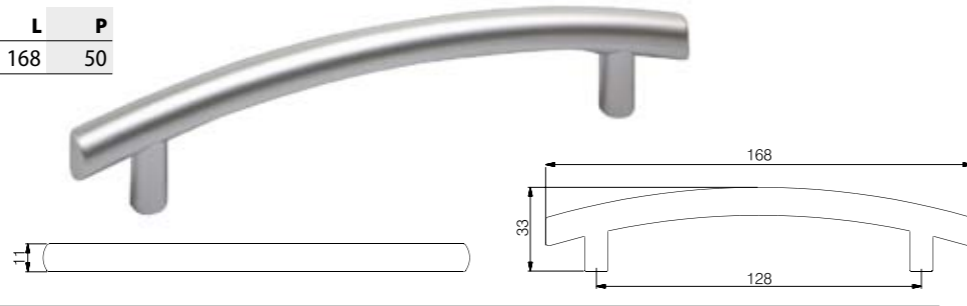

ZnAl G

VICTORIA	S	W	H	L	P
C-2123	96	17	23	138	100
C-2124	128	23	24	184	50



ZnAl G



KANSAS	S	W	H	L	P
C-1663	96	23	29	155	50

ZnAl G

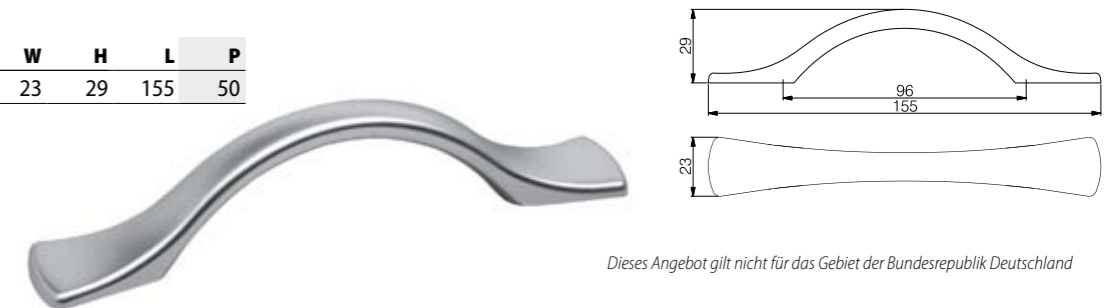

Dieses Angebot gilt nicht für das Gebiet der Bundesrepublik Deutschland



GALWAY	S	W	H	L	P
C-1743	96	13	23	141	100

ZnAl G

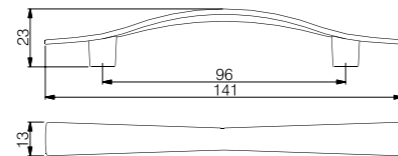

FLOW	S	W	H	L	P
C-2393	96	19	24	144	50

ZnAl G

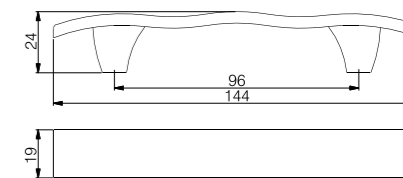

TOLEDO	S	W	H	L	P
C-1163	96	15	26	120	100

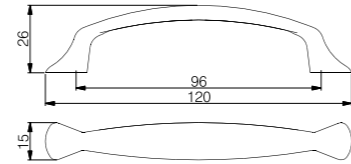

ZnAl G

**Dieses Angebot gilt nicht für das Gebiet der Bundesrepublik Deutschland*

GENEVA	S	W	H	L	P
C-1684	128	13	25	141	50

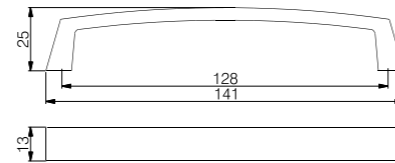

ZnAl G

RICHMOND	S	W	H	L	P
C-1214	128	14	32	141	250

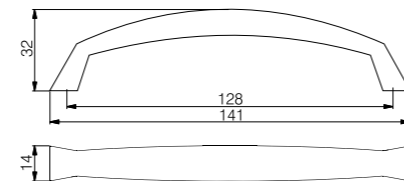

ZnAl G

WINDSOR	S	W	H	L	P
C-1243	96	11	19	107	150
*C-1244	128	13	21	140	100

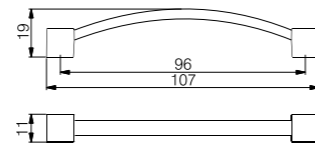

ZnAl G

**Dieses Angebot gilt nicht für das Gebiet der Bundesrepublik Deutschland*



HAITI	S	W	H	L	P
C-1525	160	12	31	172	50

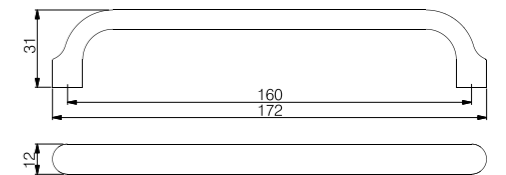

ZnAl G

NOWOŚĆ

VALENCIA	S	W	H	L	P
C-3060-148	128	11	17	148	50

*dowolny rozstaw na zamówienie klienta
any spacing on custom order
любое расстояние между отверстиями по заказу

AL A1

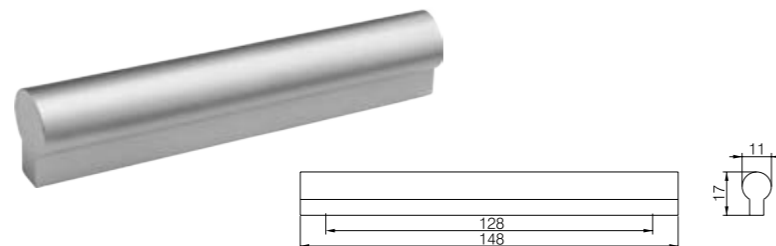

MAKAO	S	W	H	L	P
C-1760-52	32	12	24	52	100
C-1760-64	32	12	24	64	100
C-1760-84	64	12	24	84	100
C-1760-148	128	12	24	148	50

*dowolny rozstaw na zamówienie klienta
any spacing on custom order
любое расстояние между отверстиями по заказу

AL A1

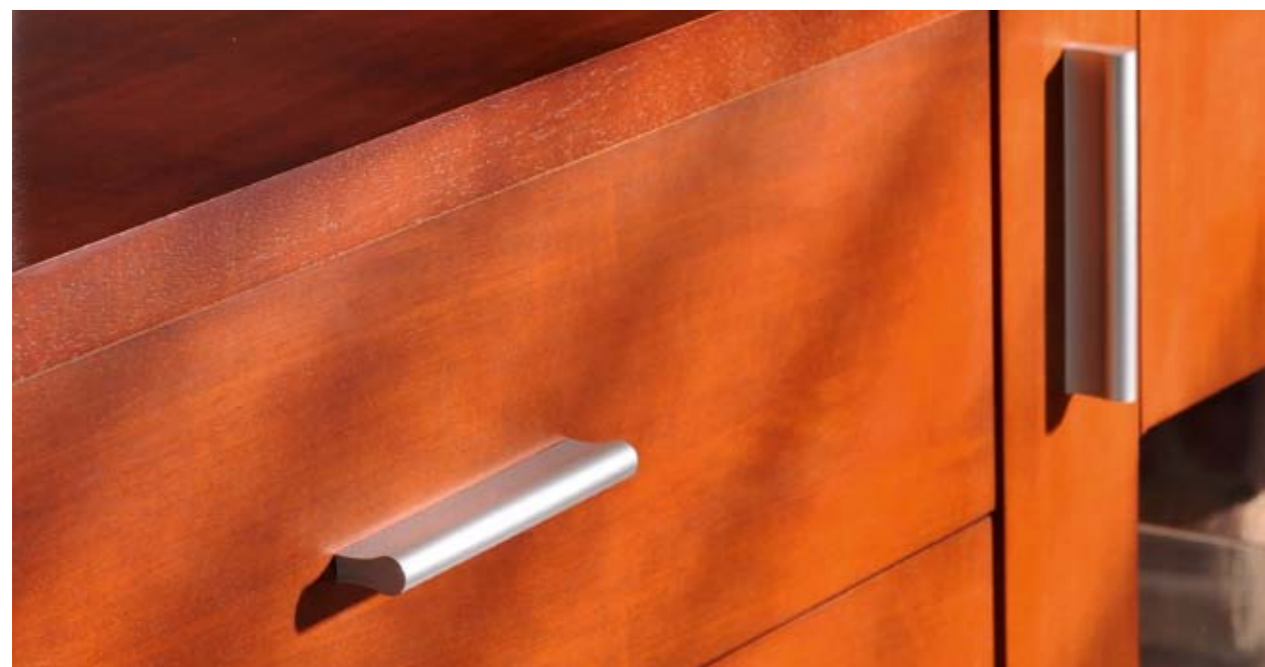
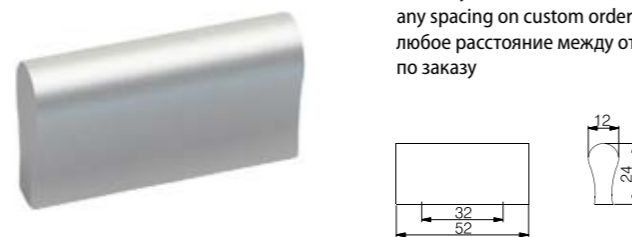

ESSEN	S	W	H	L	P
C-2020-45	32	8	28	45	150
C-2020-64	32	8	28	64	150
C-2020-106	96	8	28	106	100
C-2020-138	128	8	28	138	50

AL A1



*dowolny rozstaw na zamówienie klienta
any spacing on custom order
любое расстояние между отверстиями по заказу.

MALTA	S	W	H	L	P
C-2050-52	32	13	24	52	150
C-2050-148	128	13	24	148	50

AL A1

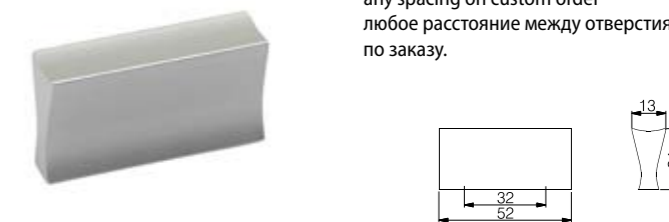

*dowolny rozstaw na zamówienie klienta
any spacing on custom order
любое расстояние между отверстиями по заказу.



KINGSTON	S	W	H	L	P
C-2360-320	160	32	27	320	50

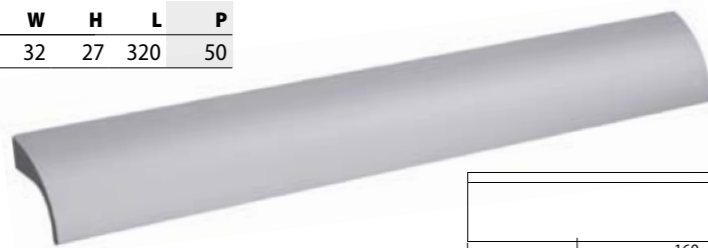

*dowolny rozstaw na zamówienie klienta
any spacing on custom order
любое расстояние между
отверстиями по заказу.

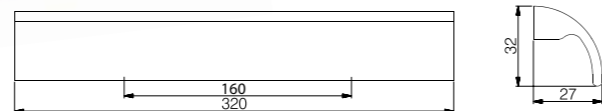

AL A1

SHANGHAI	S	W	H	L	P
C-2080-116	96	12	15	116	100



*dowolny rozstaw na zamówienie klienta
any spacing on custom order
любое расстояние между
отверстиями по заказу.

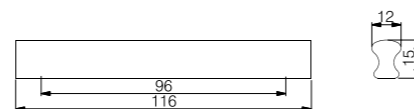

AL A1



CRETE	S	W	H	L	P	
C-519	200	21	45	252	10	kompletów / sets / комплектов

*uchwyt kabinowy, dostępny
w kompletacji 1 kpl. = 2 szt.
shower cabin handle, available
in kits 1 set = 2 pcs
ручка для душевой кабины,
доступна в комплекте
1 кпл. = 2 шт.

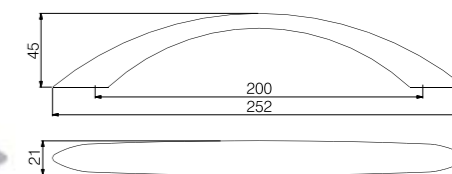

ZnAL G



THAITI	S	W	H	L	P	
C-2589	200	20	34	252	25	kompletów / sets / комплектов

*uchwyt kabinowy, dostępny w kompletacji 1 kpl. = 2 szt.
 shower cabin handle, available in kits 1 set = 2 pcs
 ручка для душевой кабины, доступна в комплекте 1 кпл. = 2 шт.

ZnAl G P

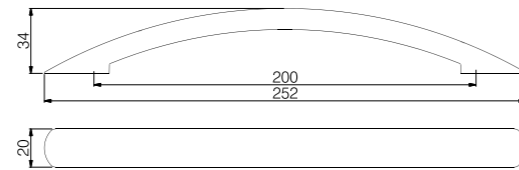

CEYLON	S	W	H	L	P	
C-2574	128	28	31	142	50	kompletów / sets / комплектов

*uchwyt kabinowy, dostępny w kompletacji 1 kpl. = 2 szt.
 shower cabin handle, available in kits 1 set = 2 pcs
 ручка для душевой кабины, доступна в комплекте 1 кпл. = 2 шт.

ZnAl G P

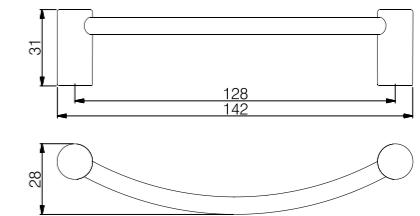

GREECE	S	W	H	L	P
C-023ST	96	10	30	142	100
C-024ST	128	10	30	174	100

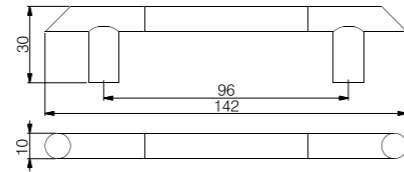

St ZnAl G

*dowolny rozstaw na zamówienie klienta / any spacing on custom order / любое расстояние между отверстиями по заказу

NOWOŚĆ

MADISON	S	W	H	L	P
C-2743	96	10	38	116	100
C-2744	128	10	38	148	150
C-2748	256	10	38	276	100

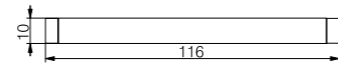
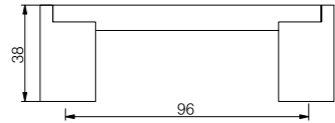

St ZnAl G

*dowolny rozstaw na zamówienie klienta / any spacing on custom order / любое расстояние между отверстиями по заказу

ATLANTIC	S	Ø	H	L	P
C-210	128	12	32	208	20
C-211	192	12	32	272	20
C-212	288	12	32	368	20
C-213	384	12	32	464	20
C-214	480	12	32	560	20
C-215	576	12	32	656	20
C-216	672	12	32	752	20
C-217	240	12	32	320	20

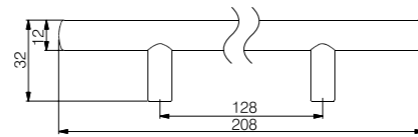
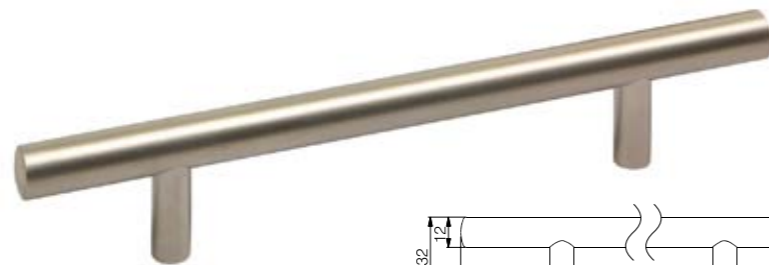

St ZnAl G

*dowolny rozstaw na zamówienie klienta / any spacing on custom order / любое расстояние между отверстиями по заказу

SANTA CRUZ	S	Ø	H	L	P
C-2100-156	96	12	32	156	20
C-2100-188	128	12	32	188	20
C-2100-208	128	12	32	208	20
C-2100-220	160	12	32	220	20
C-2100-240	160	12	32	240	20
C-2100-272	192	12	32	272	20
C-2100-304	224	12	32	304	20
C-2100-356	256	12	32	356	20
C-2100-368	288	12	32	368	20
C-2100-400	320	12	32	400	20
C-2100-432	352	12	32	432	20
C-2100-464	384	12	32	464	20
C-2100-496	416	12	32	496	20
C-2100-528	448	12	32	528	20
C-2100-560	480	12	32	560	20
C-2100-592	512	12	32	592	20
C-2100-624	544	12	32	624	20
C-2100-656	576	12	32	656	20
C-2100-752	672	12	32	752	20

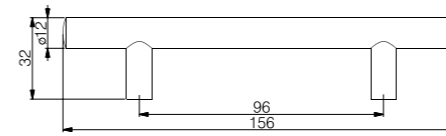

*dowolny rozstaw na zamówienie klienta
any spacing on custom order
любое расстояние между отверстиями по заказу

St ZnAl G



TOKYO	S	Ø	H	L	P
C-520-208	128	12	30	208	50
C-521-272	192	12	30	272	50
C-522-368	288	12	30	368	20

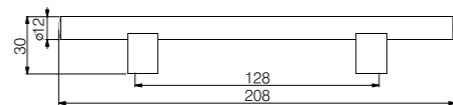

*dowolny rozstaw na zamówienie klienta
any spacing on custom order
любое расстояние между отверстиями
по заказу



St ZnAl G

CALEDONIA	S	Ø	H	L	P
C-1850-198	192	12	30	198	20
C-1850-236	230	12	30	236	20

*dowolny rozstaw na zamówienie klienta
any spacing on custom order
любое расстояние между отверстиями
по заказу

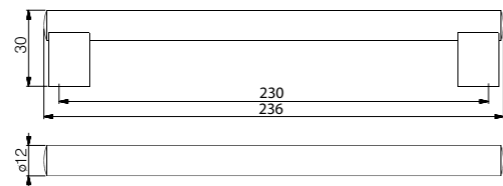
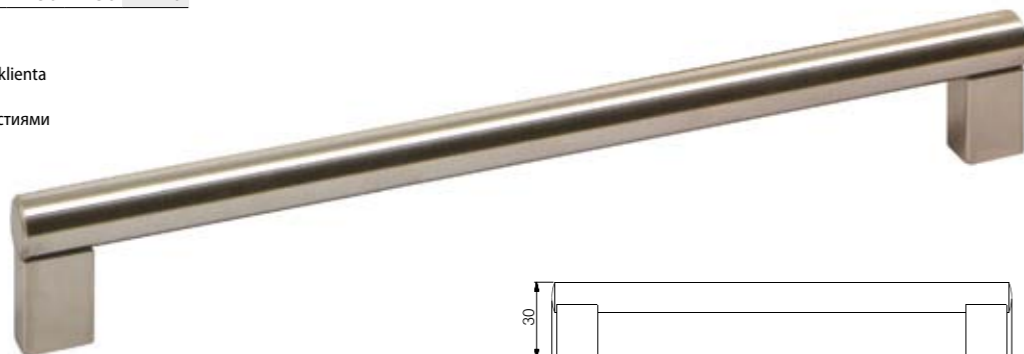

St ZnAl G





OHIO	S	Ø	H	L	P
C-1385	160	16	39	184	50
C-1386	192	16	39	216	100
C-1389-205	205	16	39	229	100
C-1389-256	256	16	39	280	20
C-1389-384	384	16	39	408	50

St ZnAl G

*dowolny rozstaw na zamówienie klienta
any spacing on custom order
любое расстояние между отверстиями по заказу

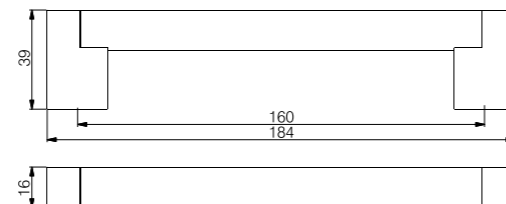

WARWICK	S	Ø	H	L	P
C-1393	96	13	36	118	50
C-1395	160	13	36	182	50
C-1396	192	13	36	214	100
C-1399-352	352	13	36	374	50
C-1399-408	408	13	36	430	20

*dowolny rozstaw na zamówienie klienta
any spacing on custom order
любое расстояние между отверстиями по заказу

St ZnAl G

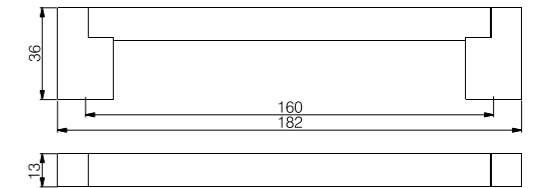

SAVANNAH	S	Ø	H	L	P
C-1403	96	12	35	118	50
C-1404	128	12	35	150	50
C-1405	160	12	35	182	100
C-1406	192	12	35	214	100
C-1408	256	12	35	278	100

*dowolny rozstaw na zamówienie klienta
any spacing on custom order
любое расстояние между отверстиями по заказу

St ZnAl G

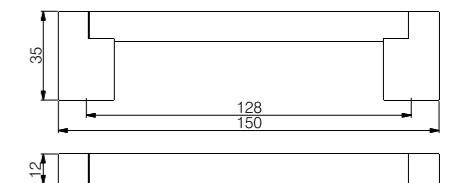



NOWOŚĆ

LOUISIANA	Ø	Ø	H	P
Z-5412	25	18	47	50

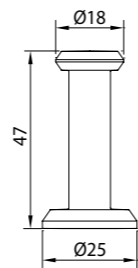

ZnAl G



YUKON	S	W	H	L	P
Z-361	20	78	30	47	50

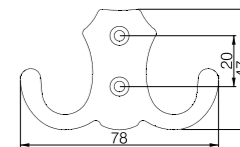
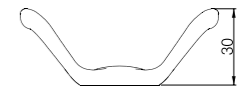

ZnAl G

CELEBES	S	W	H	L	P
Z-375	20	78	77	125	100

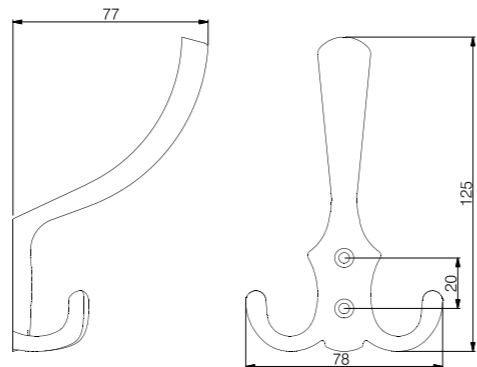

ZnAl G

DOMINICA	S	W	H	L	P
Z-391	18	58	29	32	150

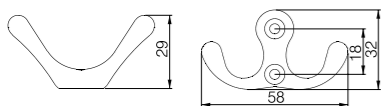

ZnAl G



JERSEY	S	W	H	L	P
Z-381	22	39	56	114	50
Z-383	22	39	89	177	50

ZnAl G



Z-381

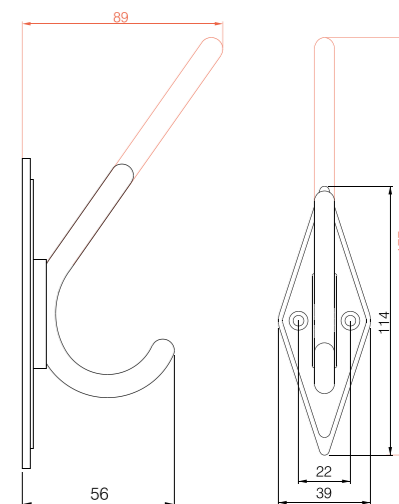



ONTARIO	Ø	H	L	P
Z-422	12	35	28	400
Z-423	15	44	33	200

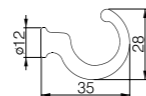

ZnAl G

ROSWELL	S	W	H	L	P
Z-5406	32	9	51	58	350

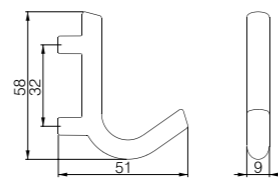

ZnAl G

NOWOŚĆ

VIGO	S	W	H	L	P
Z-5411A	32	52	87	161	5

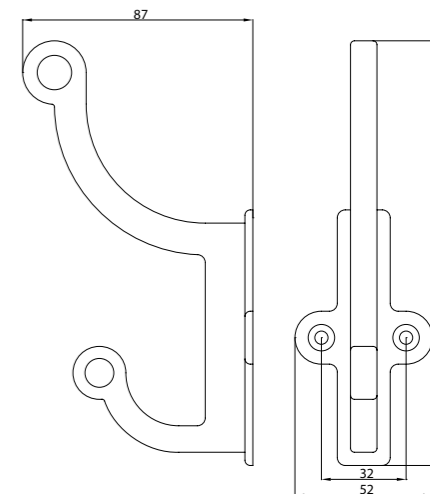

ZnAl G

NOWOŚĆ

VIGO	S	W	H	L	P
Z-5411-300	32	362	87	161	1
Z-5411-400	32	462	87	161	1
Z-5411-500	32	562	87	161	1
Z-5411-600	32	662	87	161	1



*dowolny rozstaw na zamówienie klienta – zależy od długości pręta
any spacing on custom order
любое расстояние между отверстиями по заказу

ZnAl G

Folk



CO NAM W DUSZY GRA...

Urok wydobyty z idealnego połączenia tradycji z nowoczesnością. Powrót do korzeni jest zawsze na czasie.

NOWA TECHNOLOGIA – POKRYCIA GALWANICZNE NA TWORZYWACH

NOWOŚĆ



ZALETY

- walory dekoracyjne – zwiększona paleta kolorów
- walory użytkowe – większa odporność mechaniczna od powłok malarskich
- całkowita odporność na korozję możliwość stosowania w pomieszczeniach o większej wilgotności: kuchnie, łazienki
- konkurencyjne ceny

PERILLA	Ø	H	P
A-034	28	26	100

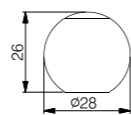

DR ZnAL D G

ARNICA	Ø	H	P
A-133	23	31	100

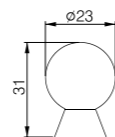

DR ZnAL D G

JASMINUM	Ø	H	P
A-143	23	26	100

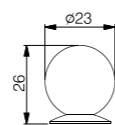

DR ZnAL D G

SELINUM	Ø	H	P
A-154	28	32	50

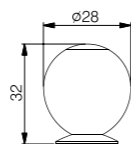

DR ZnAL D G



PRIMULA	Ø	H	P
A-236	40	30	100

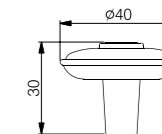

DR ZnAL D G

PIERIS	Ø	H	P
A-343	21	25	100

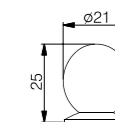

DR PLST D TL

ROSMARINUS	Ø	H	P
A-354	25	36	100

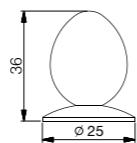

DR PLST D TL

VALERIANA	Ø	H	P
A-492	20	33	100

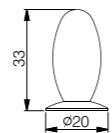

DR PLST D TL

LYCHNIS	Ø	H	P
A-534	28	32	100

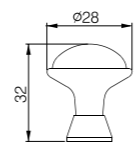

DR ZnAL D G

BRIZA	Ø	H	P
A-795	34	27	100

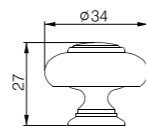

DR ZnAL D G

ABIES	Ø	H	P
A-804	30	31	100

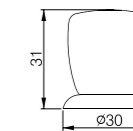

DR PLST D TL

RUMES	Ø	H	P
A-862	20	31	500

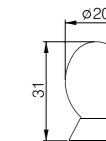

DR ZnAL D G

BEGONIA	Ø	H	P
A-963	24	29	100

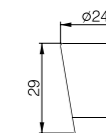

DR AL D G

BOLLA	Ø	H	P
A-984	28	34	100

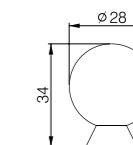

DR ZnAL D G

BERBERIS	Ø	H	P
A-1144	28	38	100

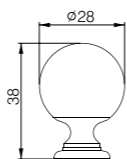

DR ZnAl D G



CROCUS	S	W	H	L	P
C-242D	64	29	33	88	50

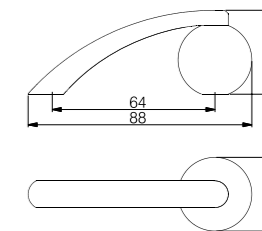

DR ZnAl D G



FORSYTHIA	S	W	H	L	P
C-363	96	28	33	132	50
C-364	128	28	33	170	100
C-367	224	32	39	270	100

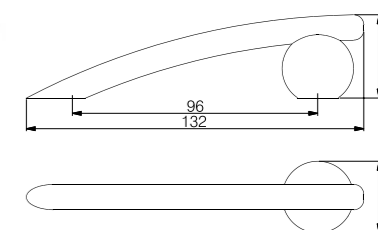

DR ZnAl D G

CALLUNA	S	W	H	L	P
C-023D	96	10	30	142	100
C-024D	128	10	30	174	50

DR ZnAl D G

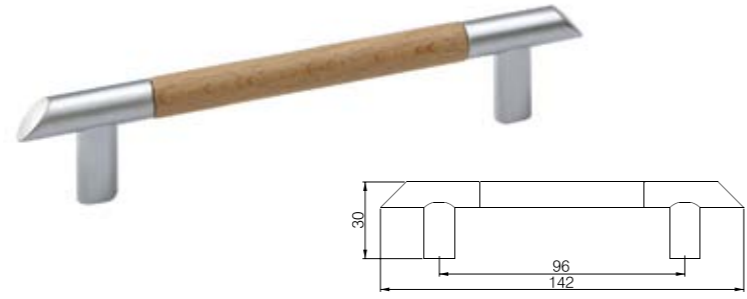

HIBISCUS	S	W	H	L	P
C-424	128	14	30	177	50

DR ZnAl D G

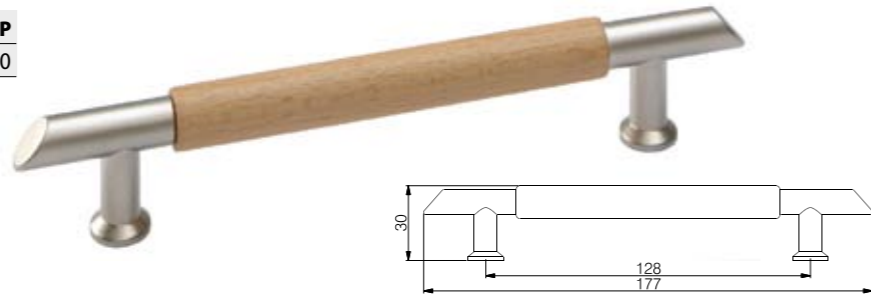

HYACINTHUS	S	W	H	L	P
C-462D	64	12	26	104	100
C-463D	96	12	26	136	50
C-464D	128	12	26	168	50

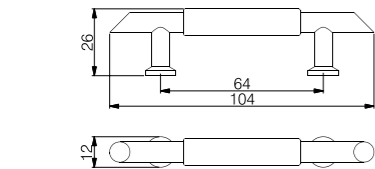

DR ZnAl D G



NEMESIA	S	W	H	L	P
C-1783	96	16	29	136	50

DR ZnAl D G





ITALICA	S	W	H	L	P
C-783	96	14	30	146	50

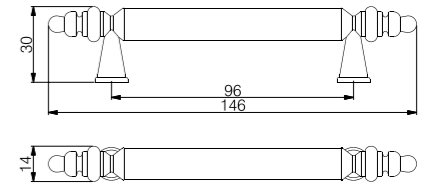

DR ZnAL D G

GALIUM	S	W	H	L	P
C-093D	96	14	30	126	100
C-094D	128	14	30	158	100

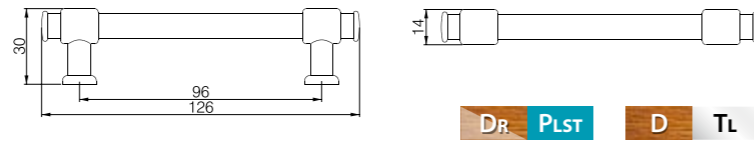

DR PLST D TL

COLLINUS	S	W	H	L	P
C-1574D	128	10	25	168	50

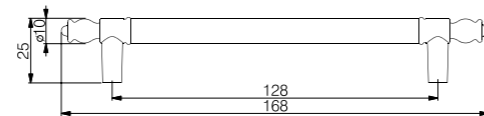

DR ZnAL D G

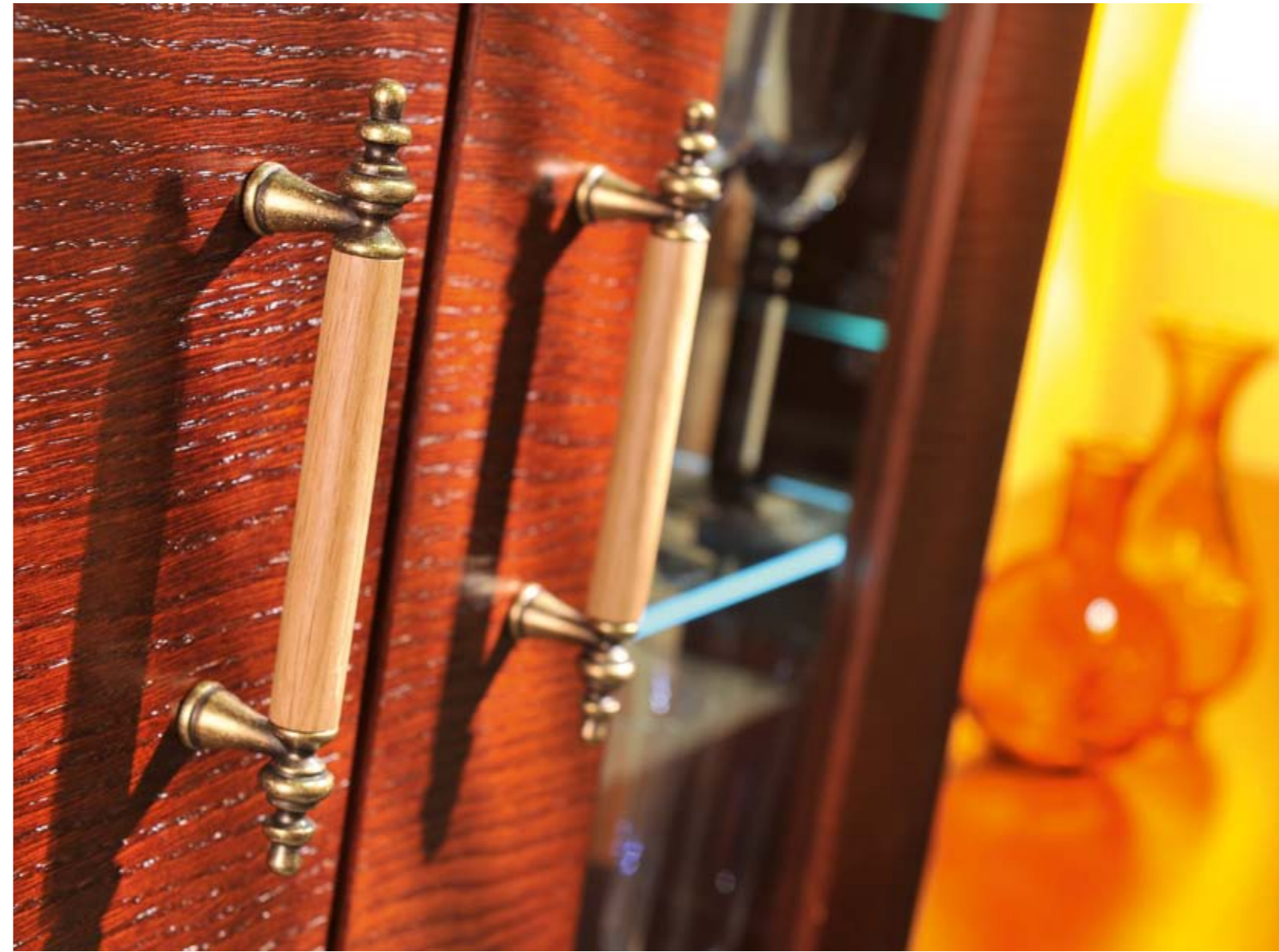

OPALUS	S	W	H	L	P
C-221	192	25	39	304	50

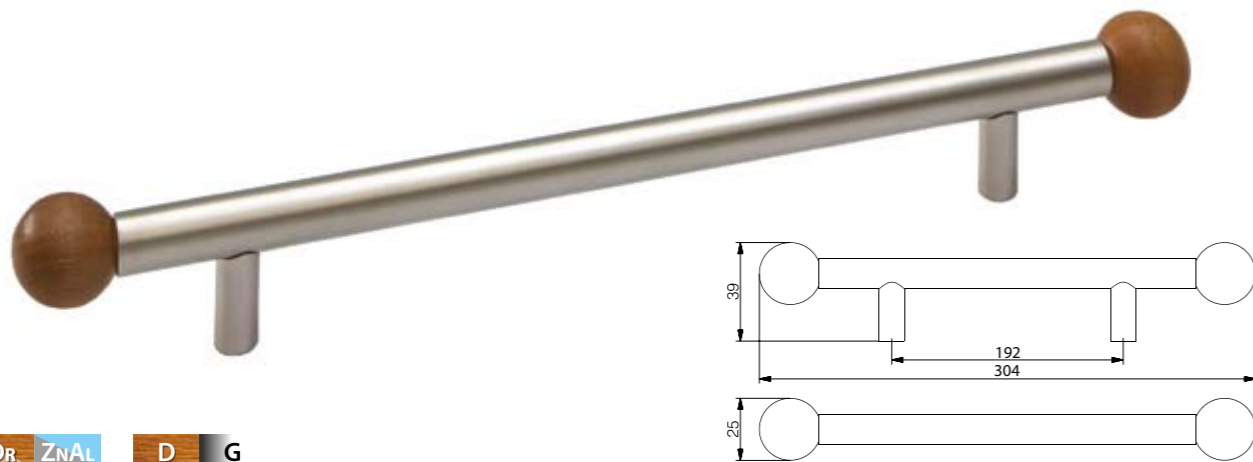

DR ZnAl D G

CLEMATIS	S	W	H	L	P
C-231	192	25	39	312	50

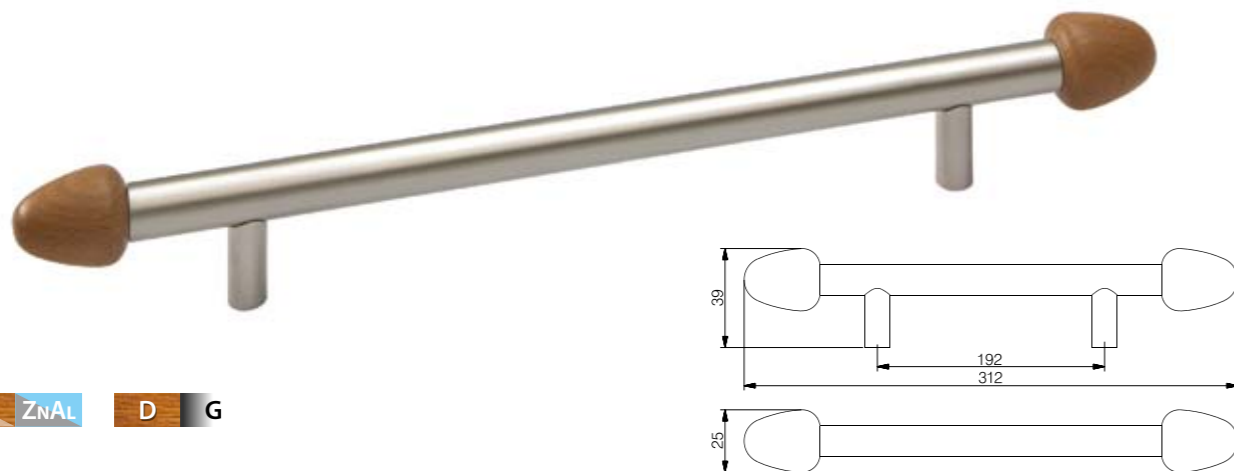

DR ZnAl D G

DAPHNE	S	W	H	L	P
C-272	64	16	33	102	100
C-273	96	16	33	134	50
C-274	128	16	33	166	50

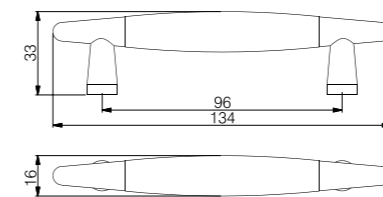

C-272



C-273



C-274

DR ZnAl D G

RUBIA	S	W	H	L	P
C-344D	128	19	33	157	50

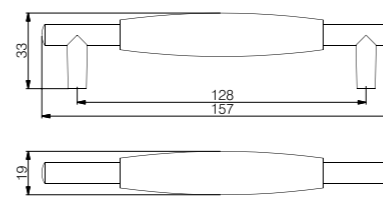

DR ZnAl D G



NOWOŚĆ

GRANDIS	S	Ø	H	L	P
C-3193	96	13	33	126	50

*zastosowanie różnych gatunków drewna
oraz dowolny rozstaw na zamówienie klienta
any spacing on custom order
любое расстояние между отверстиями по заказу

DR ZnAl TL2-D32

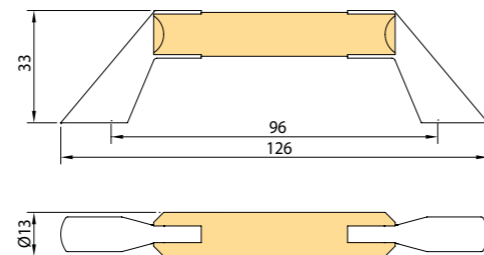

LILIUM	S	W	H	L	P
C-1463	96	20	29	108	50
C-1464	128	20	29	140	100

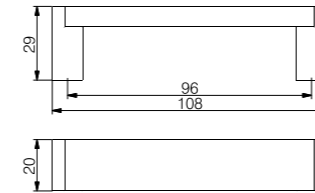

DR ZnAl D G

PETUNIA	S	W	H	L	P
C-2323	96	20	30	106	50

DR ZnAl D G



IRIS	S	W	H	L	P
C-1714	128	24	32	140	100

DR ZnAl D G

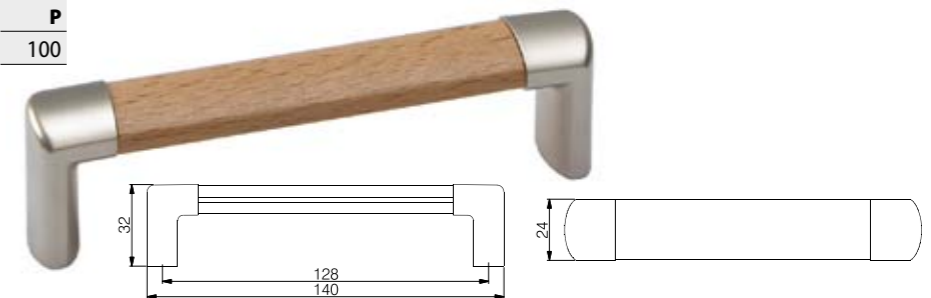



IBERIS	S	W	H	L	P
C-1504	128	24	29	137	50

DR ZnAl

D G

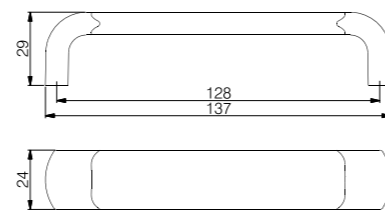

HELIANTUS	S	W	H	L	P
C-413	96	23	29	130	100

DR ZnAl

D G

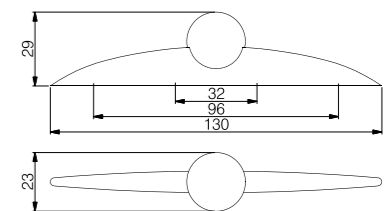

ANGELICA	S	W	H	L	P
C-393	96	13	28	108	200

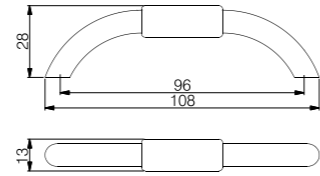

DR ZnAl D G

ERANTHIS	S	W	H	L	P
C-353D	96	14	33	109	50
C-354D	128	14	33	141	50

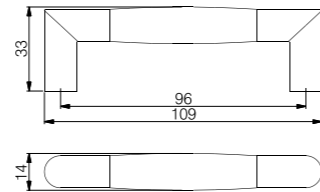

DR ZnAl D G



NOWOŚĆ

ADDO	S	W	H	L	P
C-3464	128	14	28	160	50

DR AL D G

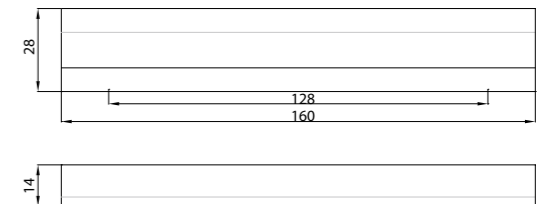

RIVINIA	Ø	H	P
A-195	31	26	100

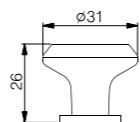

PLST TL T

URTICA	Ø	H	P
A-197	45	28	100

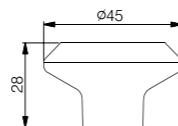

PLST TL T

PINUS	W	H	L	P
A-256	15	26	37	100

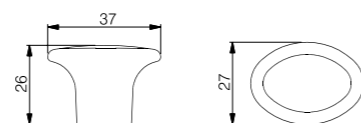

ZnAL PLST Tf/G T/G

CORTUSA	Ø	H	P
A-274	34	28	100

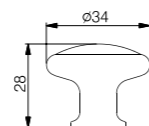

PLST ZnAL T G

APIUM	W	H	P
A-503	15	25	200

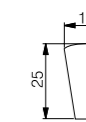

PLST TL

ORCHIS	Ø	H	P
A-522	20	26	100

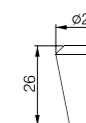

PLST TL



MAGNOLIA	Ø	H	P
A-554	38	32	100

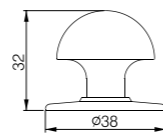

PLST TL T

BETULA	Ø	H	P
A-674	30	31	100

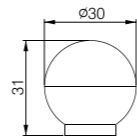

PLST TL T

QUERCUS	Ø	H	P
A-695	35	38	100

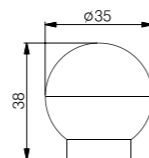

PLST TL T

PRUNUS	Ø	H	P
A-843	25	21	100

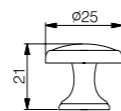

PLST ZnAL T G

BRUNIA	Ø	H	P
A-1002	20	21	100

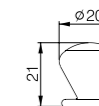

PLST ZnAL T G

RIBES	W	H	L	P
A-1202	10	34	21	100

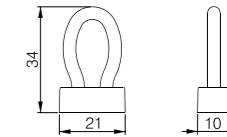

Sk ZnAL G





ROBINIA	S	W	H	L	P
C-033	96	16	26	148	100

PLST TL T

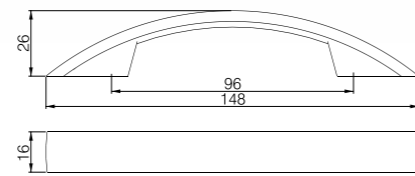

SCILIA	S	W	H	L	P
C-083	96	16	26	148	100

PLST TL T

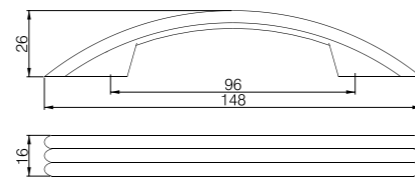

ANTURIUM	S	W	H	L	P
C-2443	96	16	26	115	100

PLST TL T

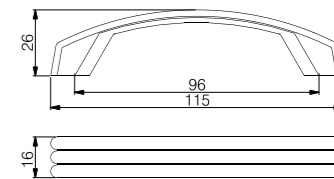

ROSA	S	W	H	L	P
C-043	96	16	30	138	50

PLST T TF

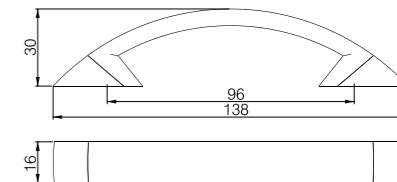

SALVIA	S	W	H	L	P
C-053	96	19	28	124	50

PLST TL T

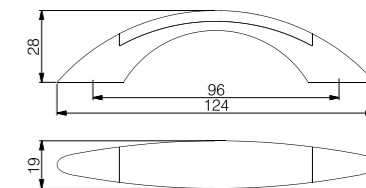

ELISMA	S	W	H	L	P
C-2523	96	17	25	140	100

PLST TL T

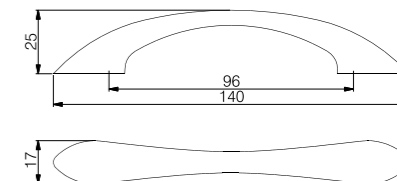

VITIS	S	W	H	L	P
C-533	96	12	25	126	50

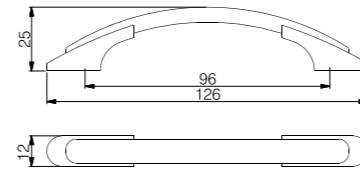

PLST TL T

CEDRUS	S	W	H	L	P
C-1673	96	13	25	109	100

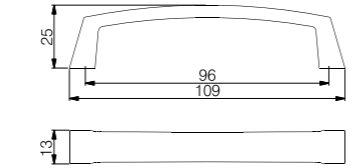

PLST TL T

AVENA	S	W	H	L	P
C-473	96	10	29	122	100
C-474	128	10	31	150	100

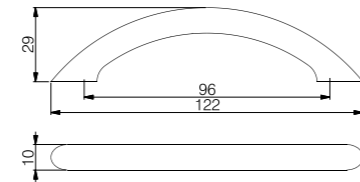

PLST TL T

HUMILIS	S	W	H	L	P
C-1594	128	18	28	140	300

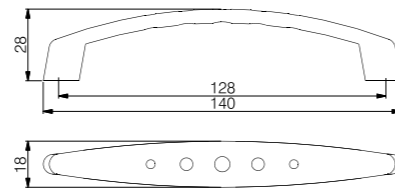

PLST

TL T

TILIA	S	W	H	L	P
C-112	64	12	23	76	100
C-113	96	14	25	106	100
C-114	128	15	28	140	100



C-112

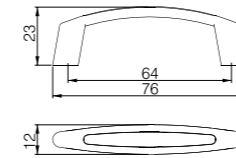

PLST ZNAl TF/G T/G



C-114

RECTA	S	W	H	L	P
C-923	96	9	30	127	100
C-925	160	9	34	195	200



C-923

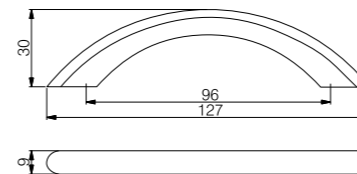

PLST TL T



C-925

VERNA	S	W	H	L	P
C-1151	32	12	24	62	100
C-1154	96/128	12	24	149	50

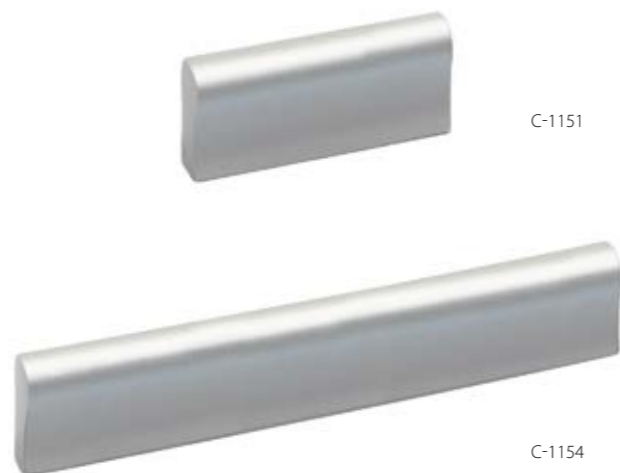
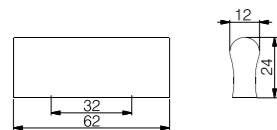

C-1151

C-1154

PLST TL

VALLUM	S	W	H	L	P
C-2170-116	96	12	24	116	50
C-2170-148	128	12	24	148	50
C-2170-210	192	12	24	210	50
C-2170-300	224	12	24	300	100

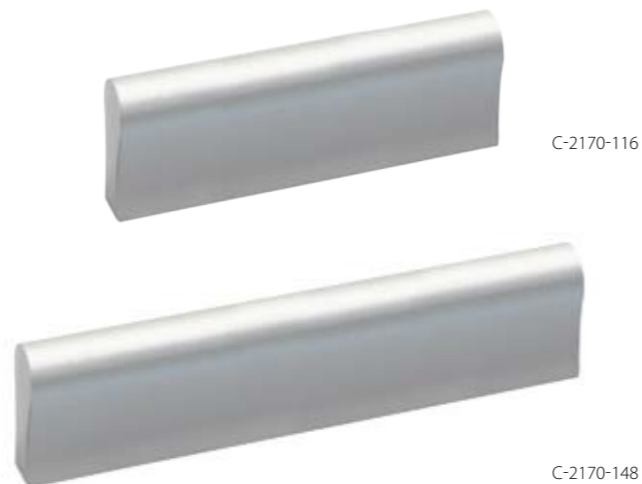
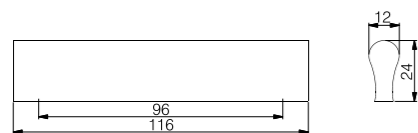

C-2170-116

C-2170-148

*dowolny rozstaw na zamówienie klienta
any spacing on custom order
любое расстояние между отверстиями по заказу

PLST TL



GALANTHUS	S	W	H	L	P
C-093T	96	14	30	126	50
C-094T	128	14	30	158	100

PLST TL T

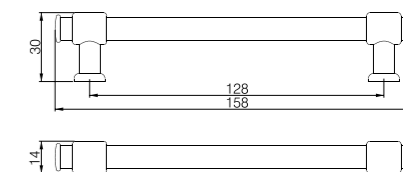



CORNUS	S	W	H	L	P
C-462T	64	12	25	104	50
C-463T	96	12	25	136	150
C-464T	128	12	25	168	50

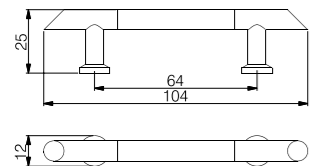

PLST ZnAl T G



WISTERIA	S	W	H	L	P
C-572	64	22	25	72	50

PLST TL T

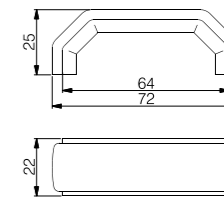

ANNAGALLIS	S	W	H	L	P
C-162	64	10	28	74	100
C-163	96	10	28	106	100
C-168	80	10	28	90	100

PLST TL T

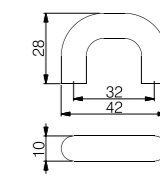



TULIPA	S	W	H	L	P
C-123	96	21	24	151	50

PLST TL T

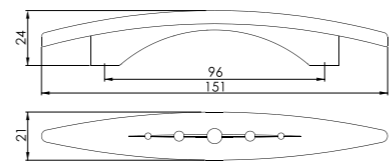

DATURA	S	W	H	L	P
C-2354	128	21	21	160	50

PLST TL

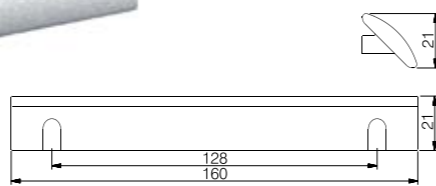

BELLIS	S	W	H	L	P
C-981	32	18	22	51	100
C-983	96	18	28	116	150
C-984	128	18	28	148	150
C-985	160	18	28	180	100

PLST TL G

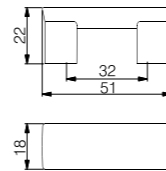

C-981



C-984



NOWOŚĆ

TAMARIX	S	W	H	L	P
A-1332	15	31	40	50	
C-2993	96	15	31	136	50
C-2994	128	15	31	168	50
C-2995	160	15	31	200	50
C-2997	224	15	31	264	50



A-1332

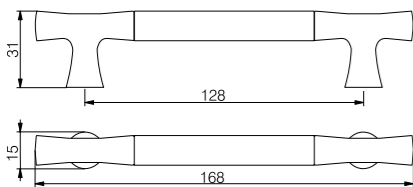
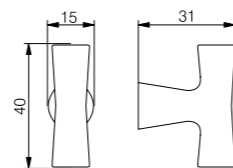

C-2994

Dr ZnAl D G



DELIMA	S	Ø	H	L	P
C-262	64	10	28	96	50
C-263	96	10	28	128	50
C-264	128	10	28	160	50
C-265	160	10	28	192	50
C-268	80	10	28	112	50



C-263

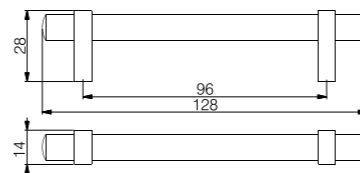

C-264

St ZnAl G

*dowolny rozstaw na zamówienie klienta
any spacing on custom order
любое расстояние между отверстиями по заказу

BLANDA**Z-403**

Ø	H	L	P
18	178	73	100

PLST

TL T

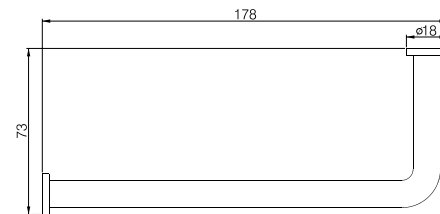
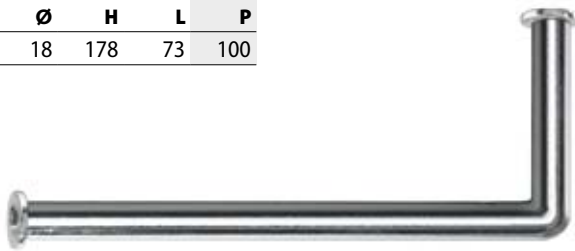
**NOBLIS****Z-404**

S	W	H	L	P
18	18	93	154	100

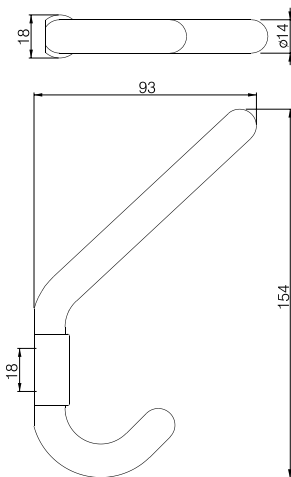

PLST

TL T



Modern



SPOJRZENIE W PRZYSZŁOŚĆ...

Prostota i minimalizm – oto czym urzekają uchwyty z rodziny modern. To idealne rozwiązanie dla ceniących równocześnie komfort i styl.

AMBIENT	\varnothing	H	P
A-312	25	25	100

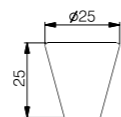

ZnAl G

ELECTRO	\varnothing	H	P
A-753	28	24	50

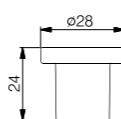

ZnAl G

LAIKO	S	W	H	L	P
A-892	16	8	18	44	100

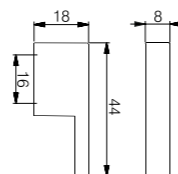

ZnAl G

RAGA	S	W	H	L	P
A-1163	12	13	19	39	100

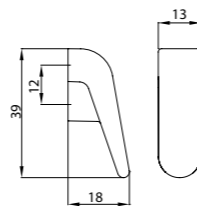

ZnAl G

Dieses Angebot gilt nicht für das Gebiet der Bundesrepublik Deutschland

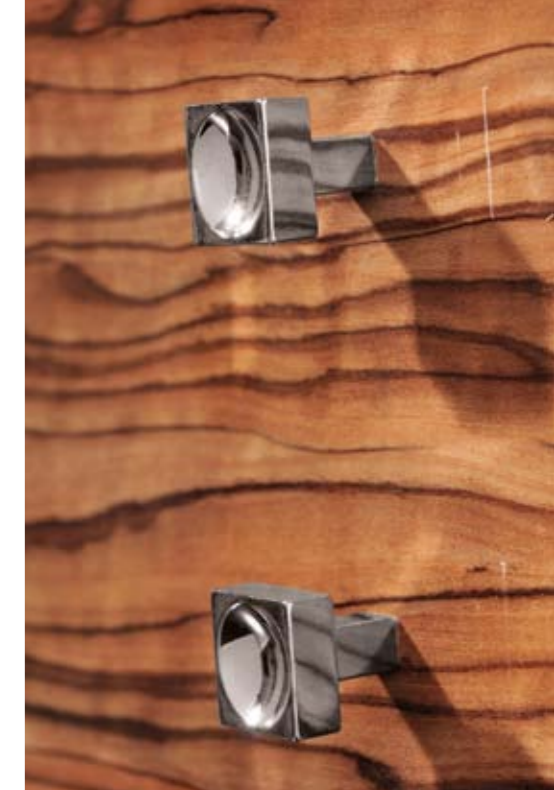

NOWOŚĆ

REGGAE	W	H	L	P
A-1272	20	23	20	50

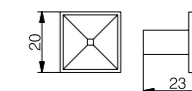

ZnAl G

NOWOŚĆ

SOUL	W	H	L	P
A-1282	20	23	20	50

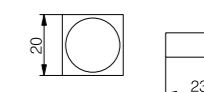

ZnAl G

NOWOŚĆ

PUNK	S	W	H	L	P
A-1302	16	23	26	46	50

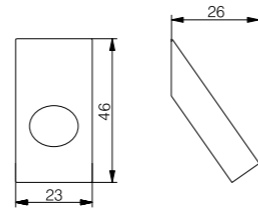

ZnAl G

NOWOŚĆ

BLUES	W	H	L	P
A-1313	45	22	45	100

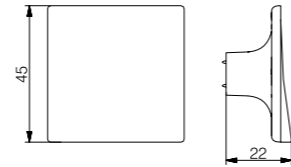
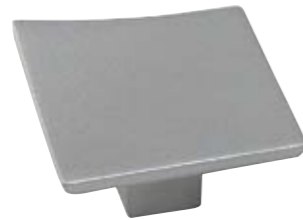

ZnAl G



NOWOŚĆ

CALYPSO	W	H	L	P
A-1405	55	24	55	10

ZnAl PLSt

G2 G5 G6
 T10 T37 T38 T39 T40

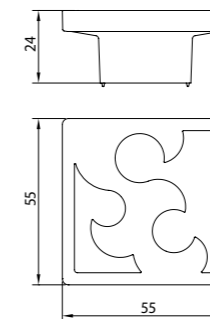

NOWOŚĆ

TRIP HOP	W	H	L	P
A-1415	60	24	60	10

ZnAl PLSt

G2 G5 G6
 T10 T37 T38 T39 T40

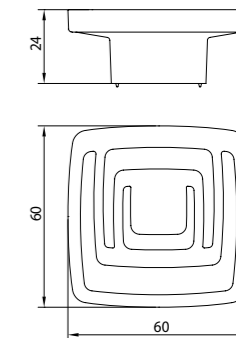



NOWOŚĆ

GRIME	Ø	H	P
A-1425	65	25	10

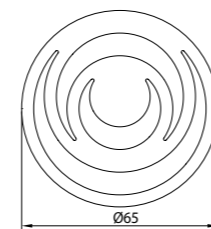

ZnAl PlSt G2 G5 G6 T10 T37 T38 T39 T40

PUMPIN	W	H	L	P
C-3031	70	26	80	50

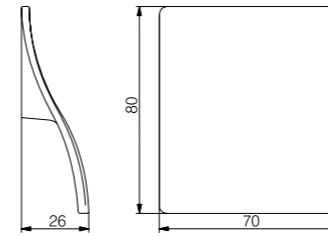

ZnAl G

JAZZ	W	H	L	P
C-3042	85	30	84	50

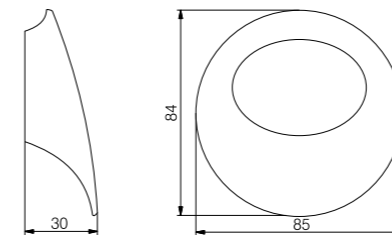

ZnAl G



NOWOŚĆ



NOWOŚĆ



GRUNGE	S	W	H	L	P
A-945		20	25	32	100
C-1693	96	24	24	108	50
C-1696	192	24	24	204	50



A-945

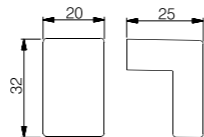

C-1693

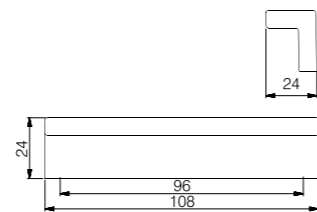

ZnAl G



SKA	S	W	H	L	P
A-955		22	18	50	100
C-1891	32	50	18	50	100
C-1892	64	50	18	80	50



A-955

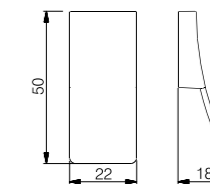

C-1891

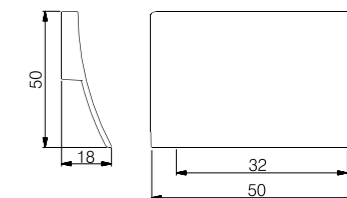

ZnAl G

NOWOŚĆ

DISCO	S	W	H	L	P
C-2913	96	10	35	122	50
C-2914	128	10	35	154	50
C-2915	160	10	35	186	50

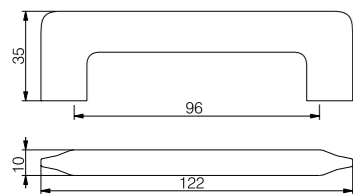

C-2913

ZnAl G

NOWOŚĆ

BAUNS	S	W	H	L	P
C-2931	32	10	28	52	50
C-2934	128	10	28	148	50
C-2935	160	10	28	180	50

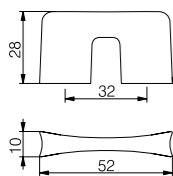

C-2931

C-2934

ZnAl G



NOWOŚĆ

HOUSE	S	W	H	L	P
C-2951	32	8	34	55	50
C-2954	128	8	34	151	50
C-2955	160	8	34	183	50
C-2957	224	8	34	247	50
C-2958	256	8	34	279	50
C-2959-320	320	8	34	343	50

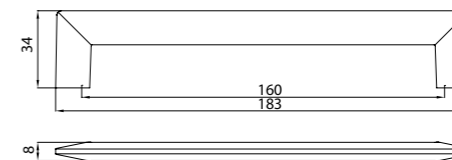

ZnAl G



NOWOŚĆ

TECHNO	S	W	H	L	P
C-761	32	8	26	57	150
C-763	96	8	28	130	50
C-764	128	8	27	150	100
C-764B	128	8	28	162	50
C-769-320	320	8	28	354	100

wprowadzamy
nowy rozstaw

ZnAl G

C-763

C-769-320

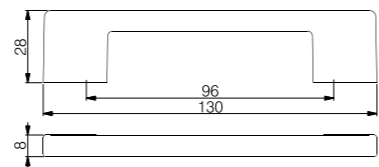

TECHNO	S	W	H	L	P
C-1143	96	9	30	137	50
C-1145-17*	160	9	56	204	50
C-1145-24*	160	9	49	204	50
C-1146	192	9	30	204	50

C-1143

C-1145-17

*uchwyt z adapterem do płyty meblowej 16 mm
handle with adapter for furniture plate 16 mm
ручка с адаптерами 16 мм

ZnAl G

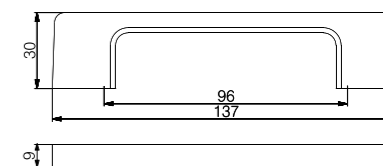



DUBSTEP	S	W	H	L	P
C-1881	32	9	18	48	200
C-1882	64	9	18	80	150
C-1883	96	9	18	140	100

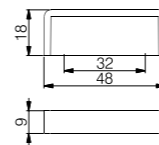

C-1881



C-1883

ZnAl G

HIP-HOP	S	W	H	L	P
C-2563	96	12	35	108	50
C-2564	128	12	35	140	50

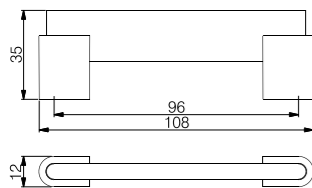

C-2563



C-2564

ZnAl G





NOWOŚĆ

STACCATO	S	W	H	L	P
C-2754	128	10	25	160	50

ZnAl G



NOWOŚĆ

TRIBAL	S	W	H	L	P
C-3374	128	9	22	159	50

ZnAl G

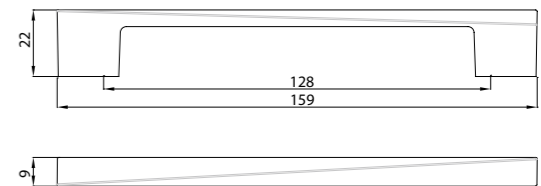

NOWOŚĆ



SMOOTH	S	W	H	L	P
C-2881	32	16	24	48	50
C-2882	64	16	24	80	50
C-2883	96	16	24	112	25
C-2884	128	16	24	144	25

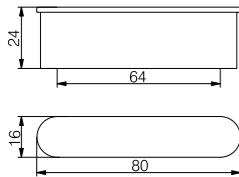

ZnAl G



C-2881

C-2883



NOWOŚĆ

FUGA	S	W	H	L	P
C-3135	128/160	8	32	215	50
C-3137	224	8	32	250	100

ZnAl G

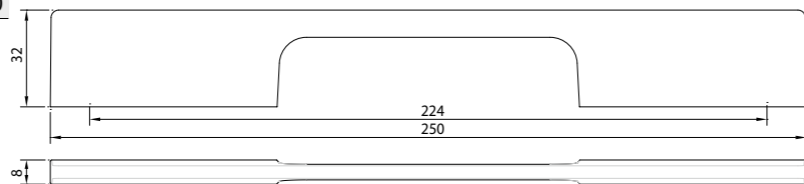

NOWOŚĆ

LEFT FIELD	S	W	H	L	P
C-3147	224	8	32	250	50

ZnAl G

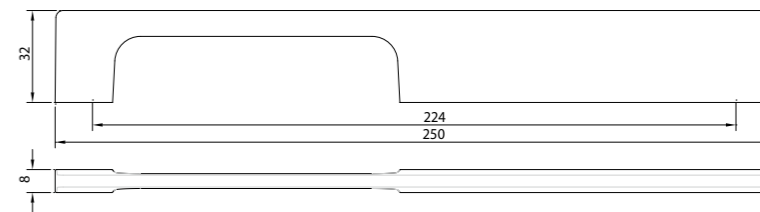

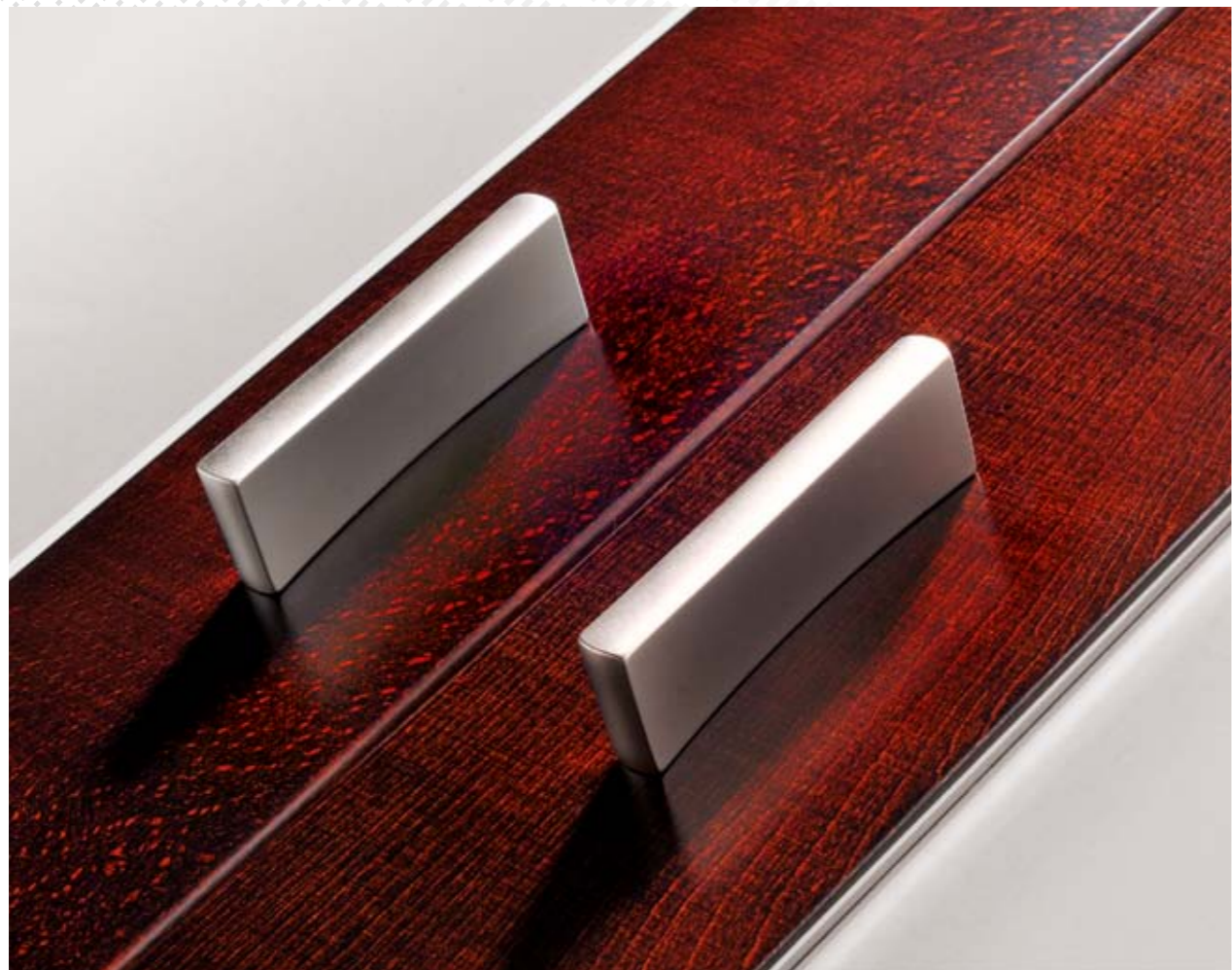

NOWOŚĆ

DAINA	S	W	H	L	P
C-3232	64	9	24	75	100

ZnAl G

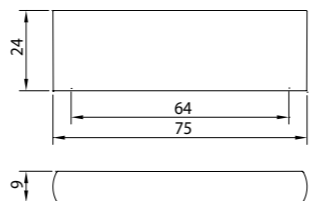

TRANCE	S	W	H	L	P
C-1515	160	22	30	197	50

ZnAl G

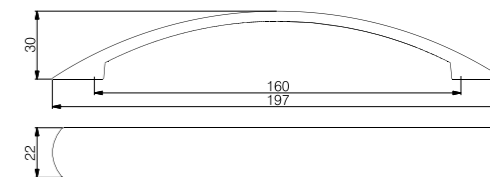

RAVE	S	W	H	L	P
C-2314	128	15	21	139	50
C-2316	192	15	21	204	50

ZnAl G

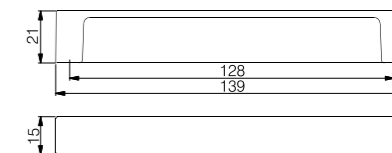

NOWOŚĆ



NOWOŚĆ

SONUS	S	W	H	L	P
C-3405	160	8	23	234	100

Dieses Angebot gilt nicht für das Gebiet der Bundesrepublik Deutschland

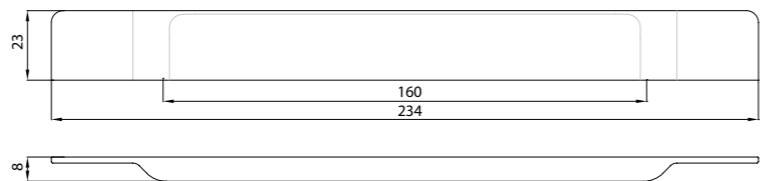

ZnAl G2 G5 G6



NOWOŚĆ

ALTERNATIVE	S	W	H	L	P
C-3274	128	10	31	192	50
C-3278	256	10	31	318	50

ZnAl G

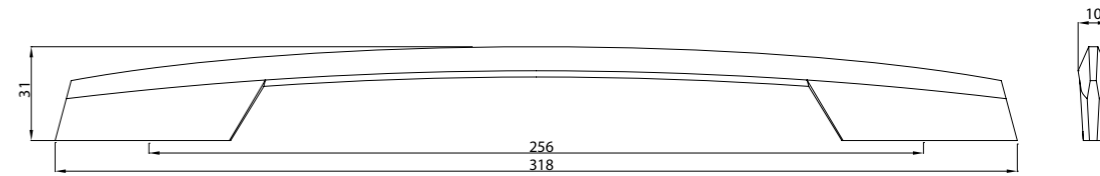



NOWOŚĆ

DEEP HOUSE	S	W	H	L	P
C-3355	160	26	38	172	50
C-3359-320	320	26	40	332	50

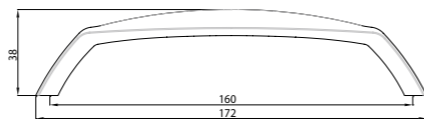

ZnAl **G2** **G5** **G6** **G8**



CIRCA	Ø	H	P
A-618	55	16	50

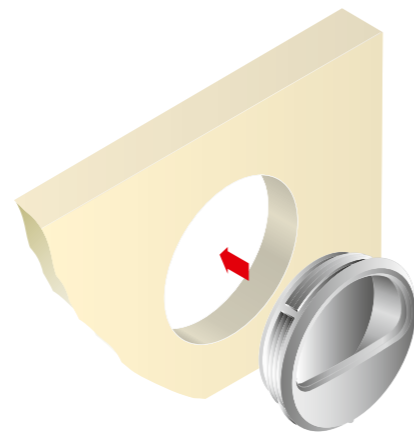
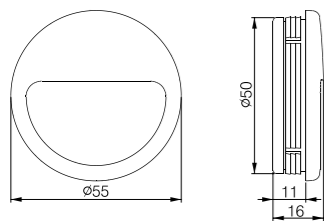

PLST TL T



ARCA	S	W	H	L	P
C-2134	128	30	17	139	50

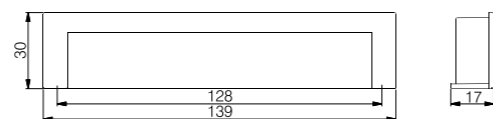
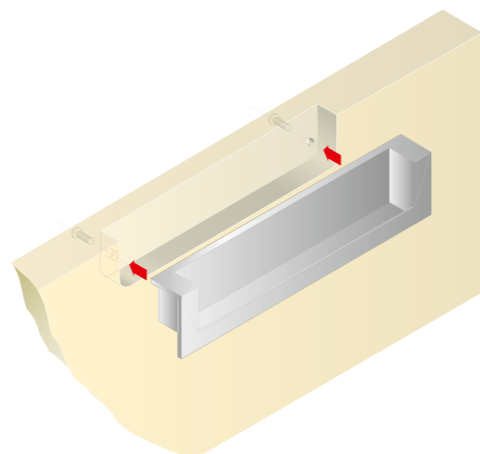

ZnAl G

QUADRUM	W	H	L	P
A-1135	45	17	45	100

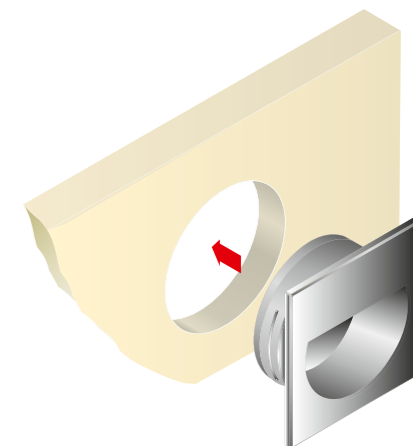
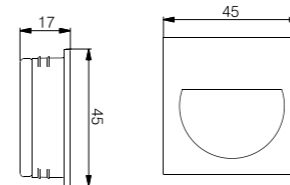

ZnAl G

TOMOR	S	W	H	L	P
C-2509	42	24	18	54	50

ZnAl G

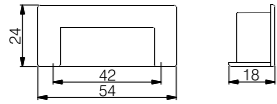
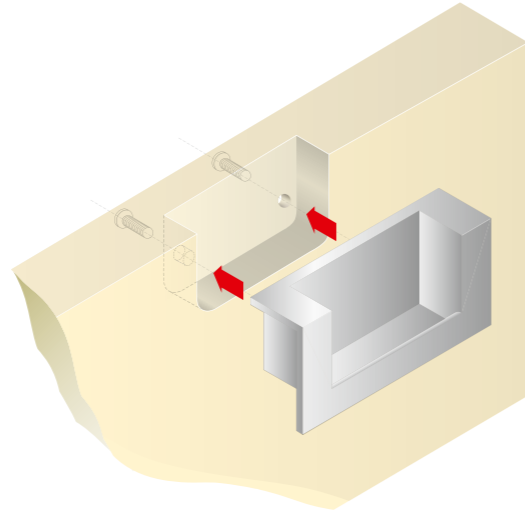

ABSTRACT	W	H	L	P
C-979	37	13	86	50

ZnAl G

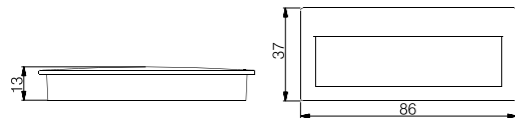
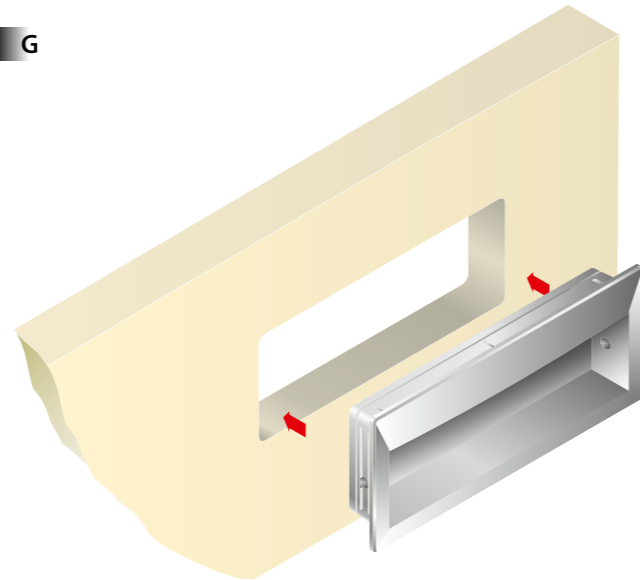

CELER	S	W	H	L	P
C-1751	32	35	17	44	100
C-1753	96	42	17	108	50
C-1755	160	42	17	174	25



C-1751

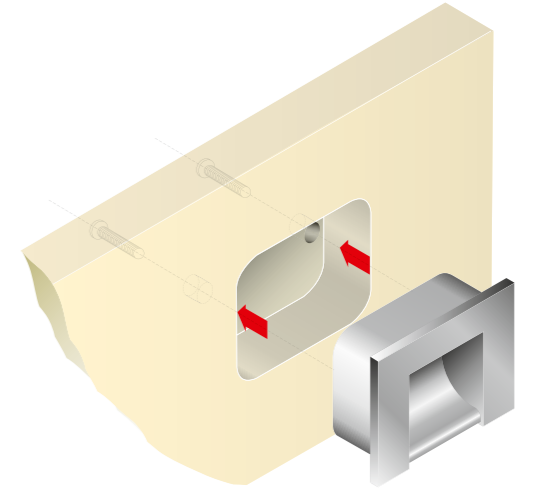

C-1753

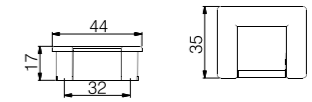

C-1755

ZnAl G



NOWOŚĆ

WALES	W	H	L	P
A-1374	30	16	36	50

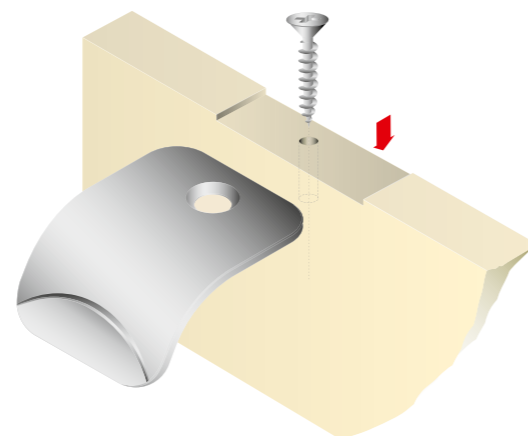
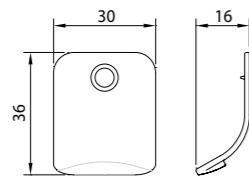

ZnAl G2 G5 G6



BASS	S	W	H	L	P
C-3184	128	35	15	160	25

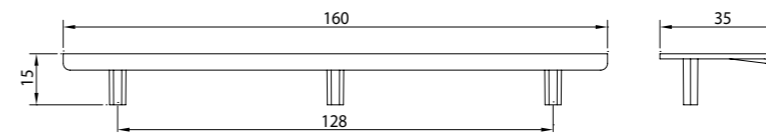

ZnAl TL2

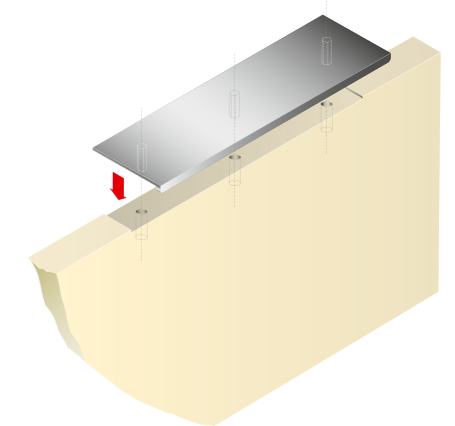



NOWOŚĆ

VOLANS	S	W	H	L	P
C-3125	160	27	18	200	50

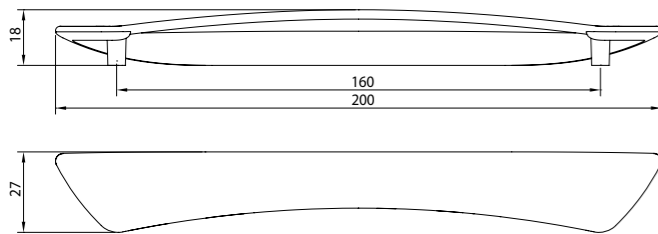

ZnAl G2 G5 G6

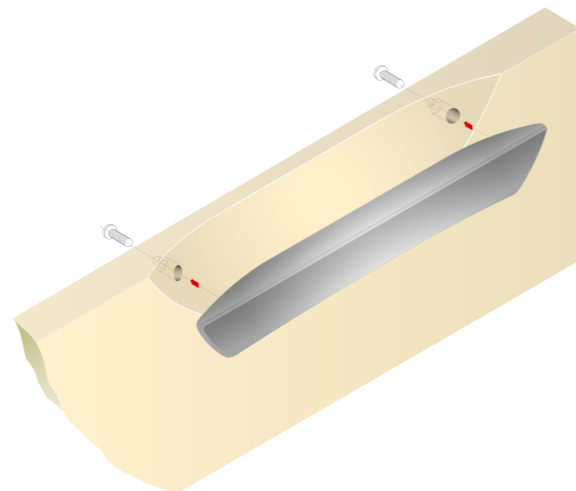

PURO	S	W	H	L	P
C-2923	96	9,4	21	150	50

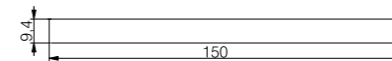
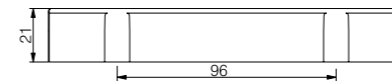

ZnAl G

LIVELLO	S	W	H	L	P
C-2292	64	20	22	85	50

Dieses Angebot gilt nicht für das Gebiet der Bundesrepublik Deutschland

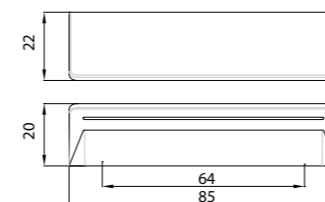

ZnAl G

NOWOŚĆ





NOWOŚĆ

LOUNGE	S	W	H	L	P
C-3154	128/192	13	30	230	50
C-3156	192/256	13	30	294	50
C-3158	256/320	13	30	358	50

AL ZnAl G2—TL2 G2—G2

*dowolny rozstaw na zamówienie klienta
any spacing on custom order
любое расстояние между отверстиями по заказу

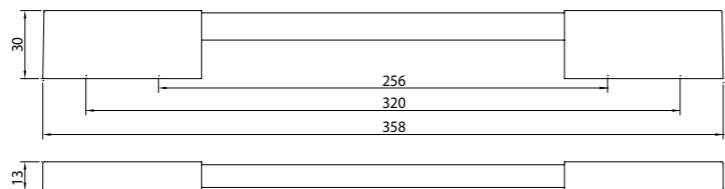

NOWOŚĆ

BREAKS	S	W	H	L	P
C-3335	160	30	20	185	50
C-3336	192	30	20	217	50
C-3338	256	30	20	271	50
C-3339-320	320	30	20	345	50

*dowolny rozstaw na zamówienie klienta
any spacing on custom order
любое расстояние между отверстиями по заказу

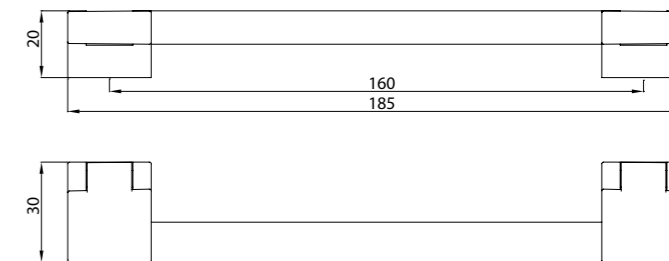

AL ZnAl A1—G6



NOWOŚĆ

CANTINA	S	W	H	L	P
C-3293	96	10	36	106	50
C-3294	128	10	36	138	50
C-3295	160	10	36	170	50
C-3296	192	10	36	202	50
C-3298	256	10	36	266	50
C-3299-320	320	10	36	330	50
C-3299-1028	1028	10	36	1038	25

*dowolny rozstaw na zamówienie klienta
any spacing on custom order
любое расстояние между отверстиями по заказу

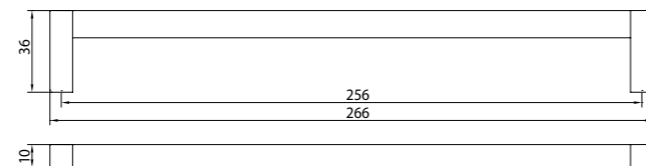

Al ZnAl TL2 G2

Uchwyt z adapterem przeznaczony do drzwi składanych o grubości 18 mm

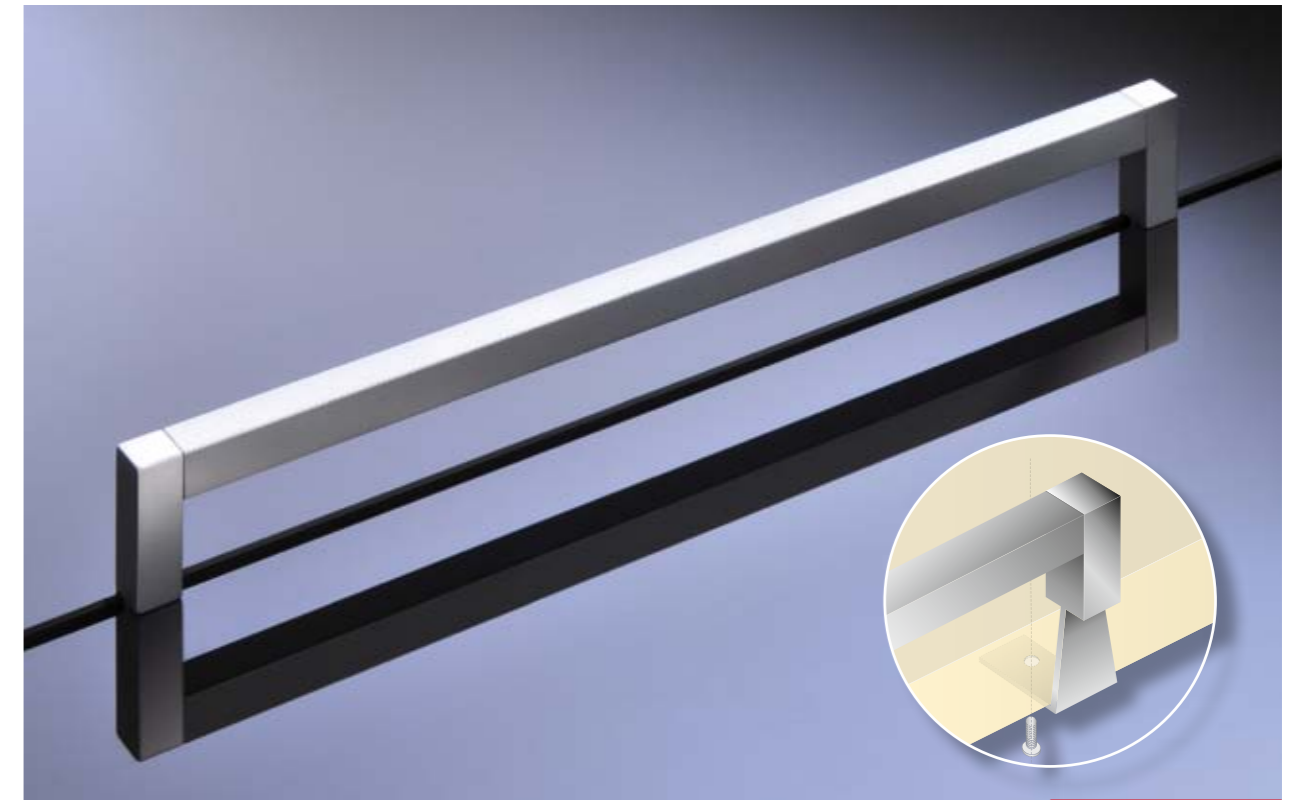

NOWOŚĆ

FUNKY	S	W	H	L	P
C-3303	96	10	36	106	20
C-3304	128	10	36	138	20
C-3305	160	10	36	170	20
C-3306	192	10	36	202	25
C-3308	256	10	36	266	25
C-3309-320	320	10	36	330	25
C-3309-1028	1028	10	36	1038	20

*dowolny rozstaw na zamówienie klienta
any spacing on custom order
любое расстояние между отверстиями по заказу

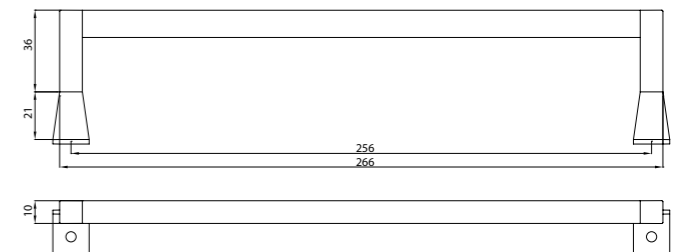

Al ZnAl TL2 G2



NOWOŚĆ

ALVEA

	S	W	H	L	P
C-3414	128	19	32	149	50
C-3415	160	19	32	181	50
C-3416	192	19	32	213	50
C-3418	256	19	32	277	50
C-3419-320	320	19	32	341	50

Al ZnAl A1 — G6

*dowolny rozstaw na zamówienie klienta
any spacing on custom order / любое расстояние между отверстиями по заказу.

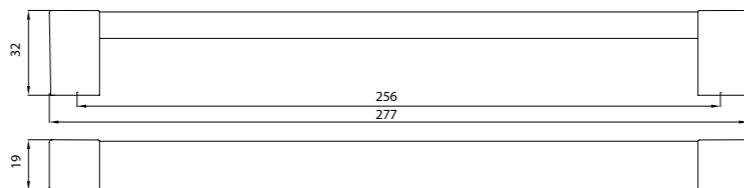

NOWOŚĆ

CLASH

	S	W	H	L	P
C-3283	96	18	30	121	20
C-3284	128	18	30	153	20
C-3285	160	18	30	185	50
C-3288	256	18	30	281	50
C-3289-320	320	18	30	345	50

Al ZnAl G2 — G2

*dowolny rozstaw na zamówienie klienta
any spacing on custom order
любое расстояние между отверстиями по заказу

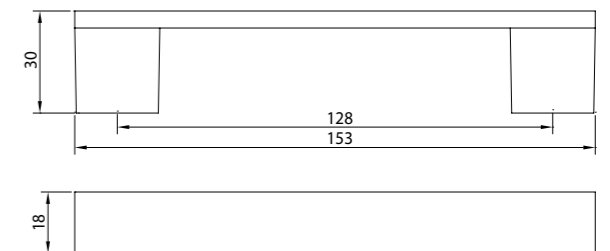



NOWOŚĆ

LEGATO

	S	W	H	L	P
C-3365	160	25	30	225	50
C-3366	192	25	30	257	50
C-3367	224	25	30	289	50
C-3368	256	25	30	321	25
C-3369-320	320	25	30	385	25
C-3369-384	384	25	30	449	25

*dowolny rozstaw na zamówienie klienta
any spacing on custom order
любое расстояние между отверстиями по заказу.

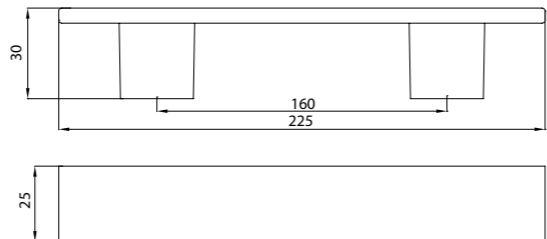

AL ZnAL G





NOWOŚĆ

ETNO	S	W	H	L	P
C-3164	128	19	29	136	50

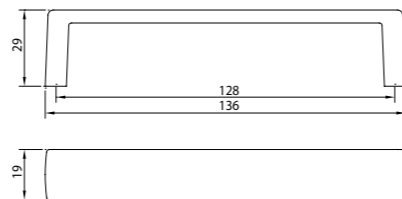

ZnAl G

NOWOŚĆ

PONS	S	W	H	L	P
C-2535	160	26	28	175	25

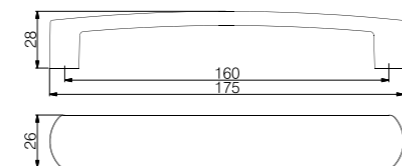

ZnAl G

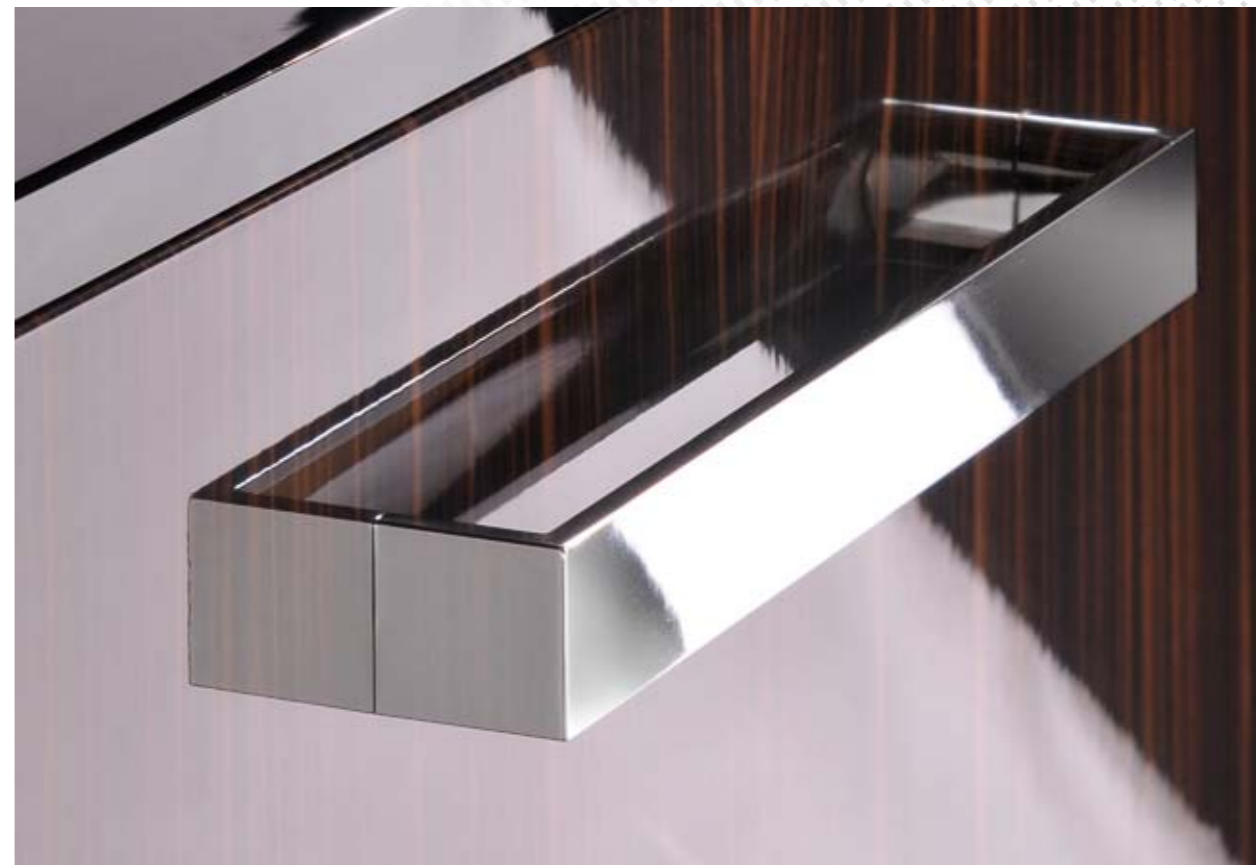

NOWOŚĆ

ASSER	S	W	H	L	P
C-3314	128	31	31	135	50
C-3318	256	31	31	263	50

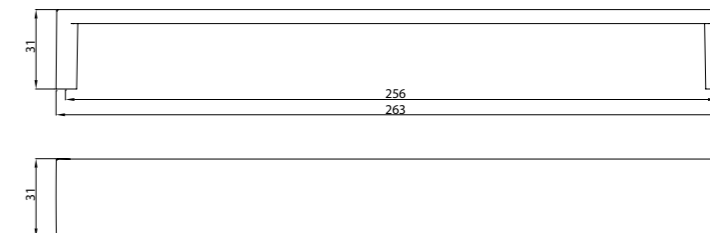

ZnAl G



LATINO

	S	W	H	L	P
C-1770-52	32	10	18	52	150
C-1770-86	64	10	18	86	100
C-1770-148	128	10	18	148	50

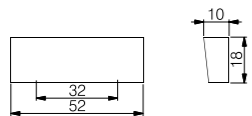

*dowolny rozstaw na zamówienie klienta
any spacing on custom order
любое расстояние между отверстиями по заказу

AL

A1

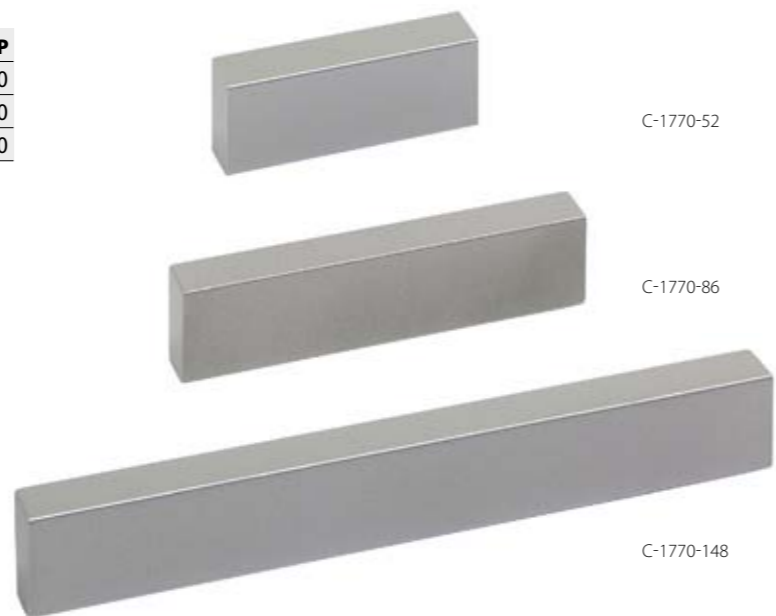

PROGRESSIVE

	S	W	H	L	P
C-2090-230	128	18	11	230	100
C-2090-415	256	18	11	415	20

*dowolny rozstaw na zamówienie klienta
any spacing on custom order
любое расстояние между отверстиями по заказу

AL

A1

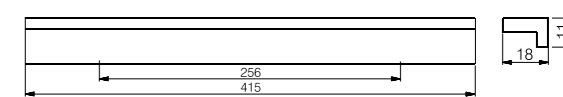



NOWOŚĆ

ACID	W	H	L	P
Z-5318	31	105	79	1

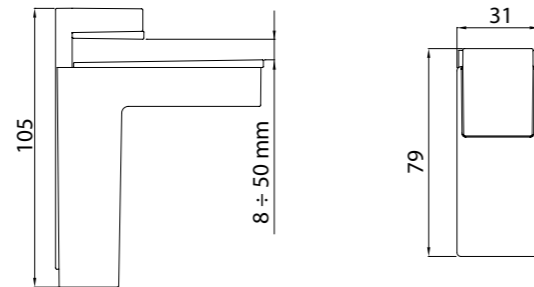

ZnAl G2 G5 G6 G8 TL 10s

DEEP	S	W	H	L	P
Z-5408	32	60	60	180	10

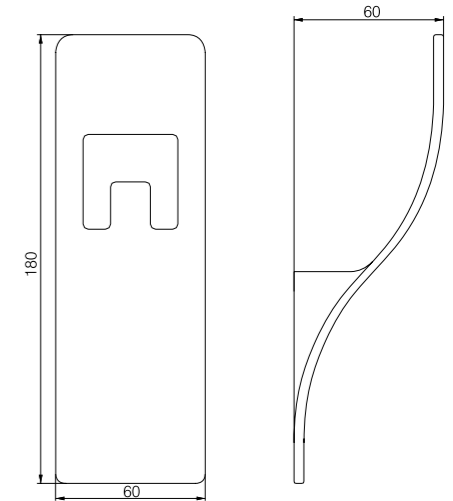

ZnAl G

NOWOŚĆ

BOOGIE	S	W	H	L	P
Z-5410	32	40	53	199	25

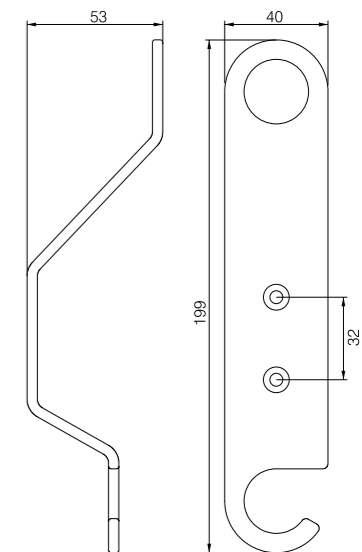

ZnAl G

NOWOŚĆ



Retro



PONADCZASOWY STYL...

Wspomnienie przeszłości.
Nieprzemijalna elegancja, zamknięta
w ozdobnych detalach, nadaje
meblom wyjątkowy charakter.
To, co najpiękniejsze, nie
wychodzi z mody....

HEBE	Ø	H	P
A-176	37	23	100

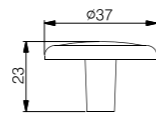

ZnAl G

ARES	Ø	H	P
A-185	33	21	100

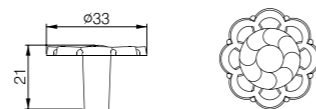

ZnAl G

DIONIZOS	Ø	H	P
A-213	25	21	100

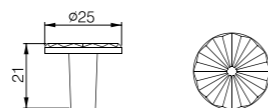

ZnAl G

PANDORA	Ø	H	P
A-922	19	16	100

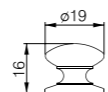

ZnAl G



ARTEMIS	Ø	H	P
A-884	30	27	100

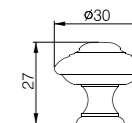

ZnAl G

MINOS	W	H	L	P
A-973	18	24	127	100

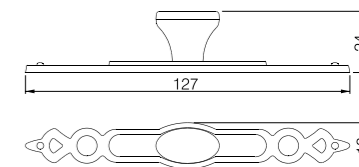

ZnAl G

MARSIAS	Ø	H	P
A-1234	30	29	100

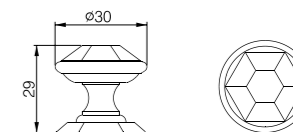

ZnAl G

HESTIA	Ø	W	H	L	P
A-013	25		23		100
E-450		34		63	100



A-013

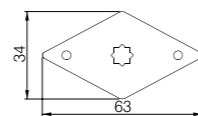
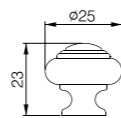

E-450

ZnAl G

PERSEFONA	Ø	W	H	L	P
A-223	25		22		100
E-380		26		75	200



A-223

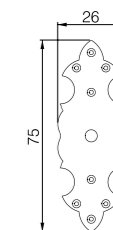
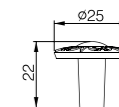

E-380

ZnAl G

DEMETER	W	H	L	P
A-025	20	21	35	100
E-460		25	79	100



A-025

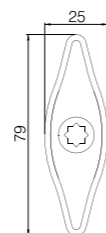
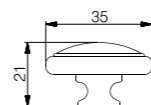

E-460

ZnAl G

AFRODYTA	Ø	W	H	L	P
A-264	28		22		100
E-350		22		80	150



A-264

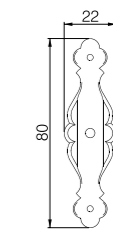
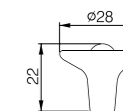

E-350

ZnAl G

PALLADA	Ø	W	H	L	P
A-763	30		22		100
E-480		28		120	100



A-763

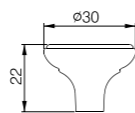

E-480

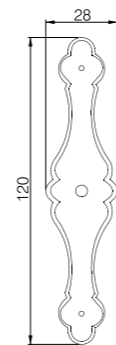

ZnAl G

APOLLO	S	Ø	W	H	L	P
A-773		30		22		100
E-490	117		28		138	100



A-773

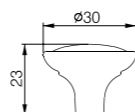

E-490

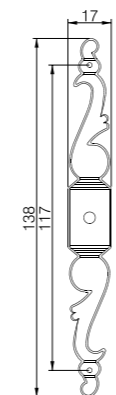

ZnAl G

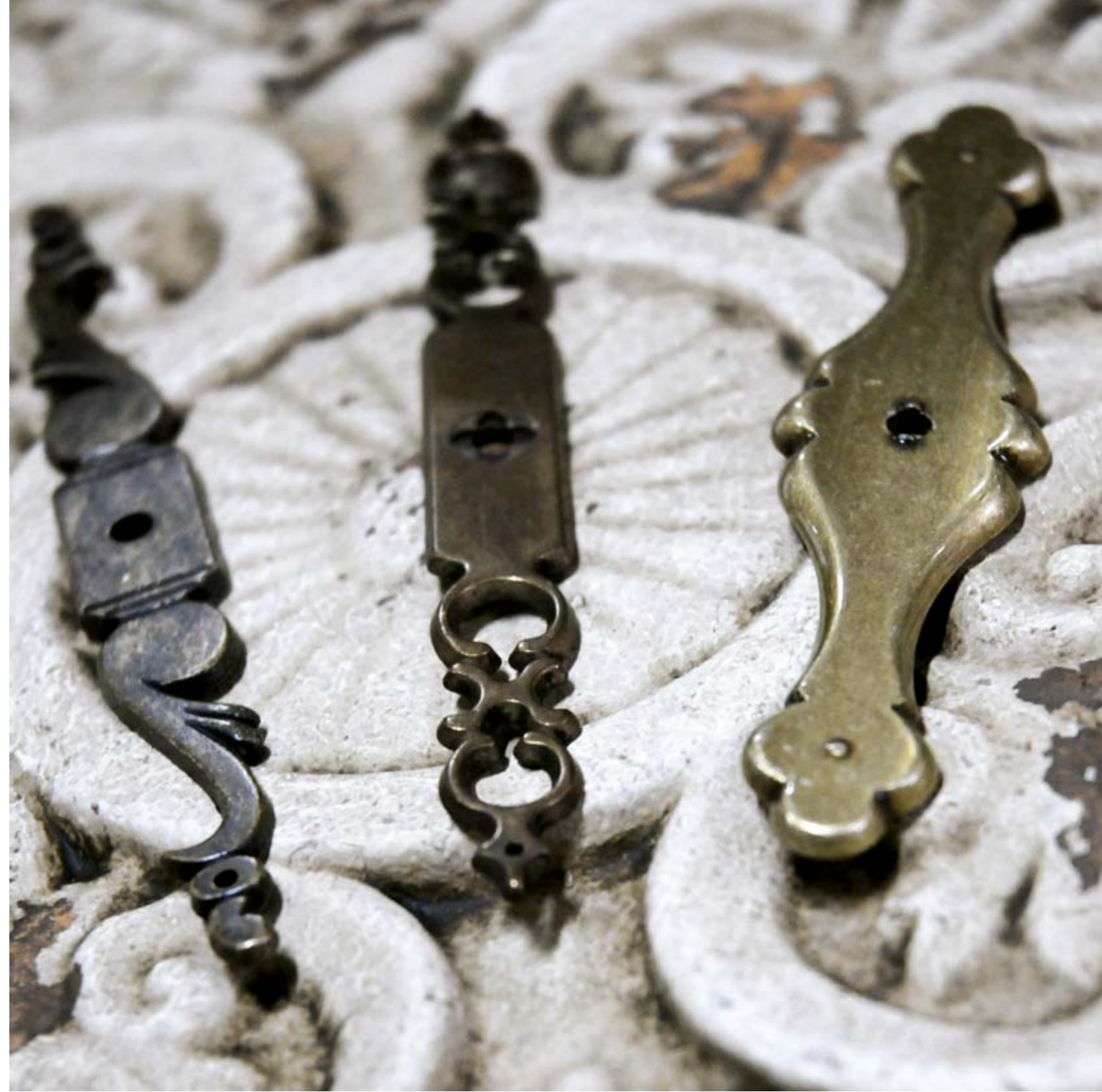



IKAR					
	Ø	W	H	L	P
A-1014	30		22		100
E-520		30		95	100
E-540		31		91	100



ZnAl G

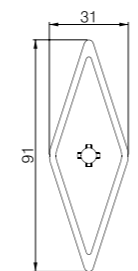
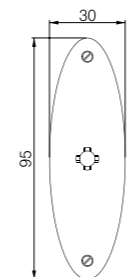
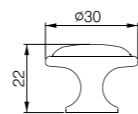

A-1014

E-520

E-540

ARTEMIDA						
	Ø	S	W	H	L	P
A-1022	25			22		100
E-560		75	25		89	100



ZnAl G

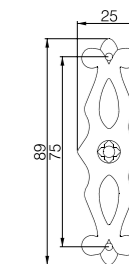
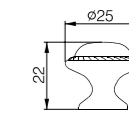

A-1022

E-560

DEDAL					
	S	W	H	L	P
A-1043			20		100
E-570	126	15		137	100

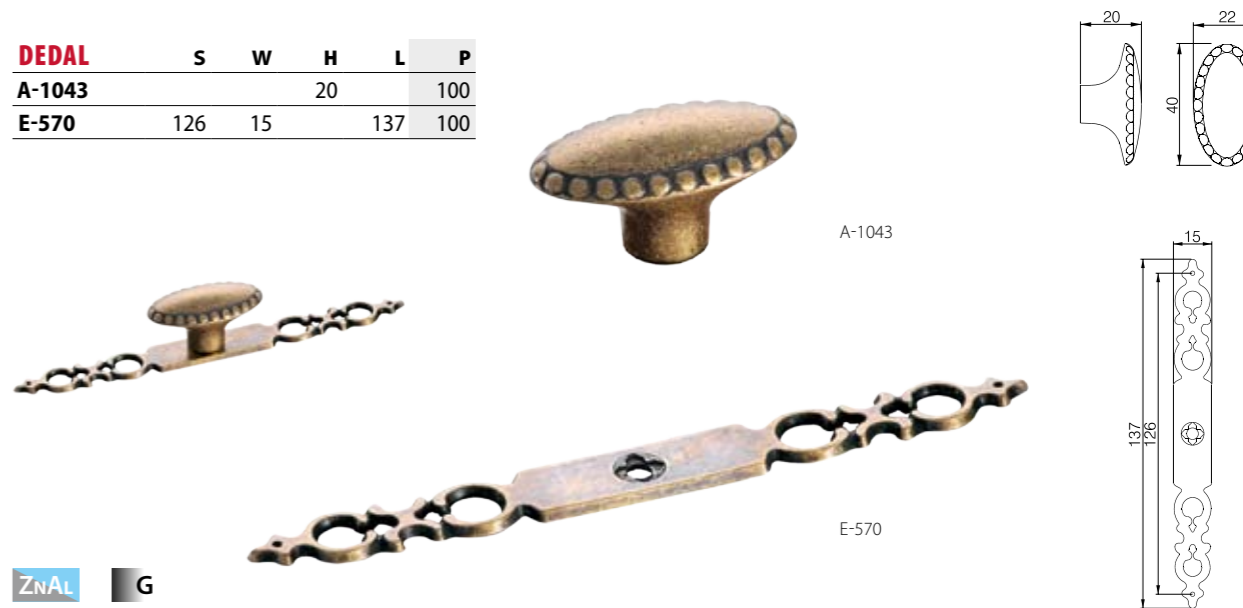

ZnAl G

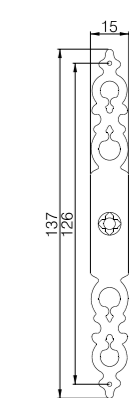
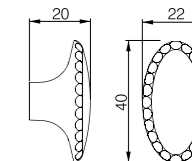

A-1043

E-570



ODYS	S	W	H	L	P
A-1222	22	21		100	
C-2553	96	22	22	118	50



A-1222

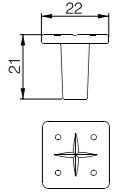

C-2553

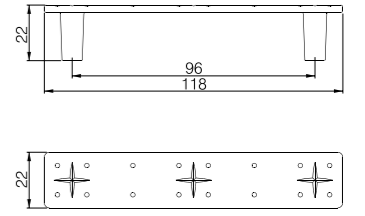

ZnAl G

PERSEUS	S	W	H	L	P
A-1053	25	27		100	
E-580	37	21	45	100	



A-1053

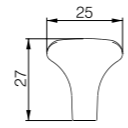

E-580

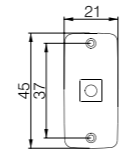

ZnAl G

CHORUS	S	W	H	L	P
C-3052	64	35	25	76	50
Z-5409	32	60	179	68	25



C-3052

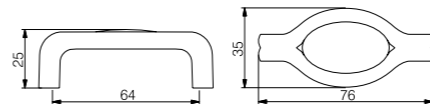

Z-5409

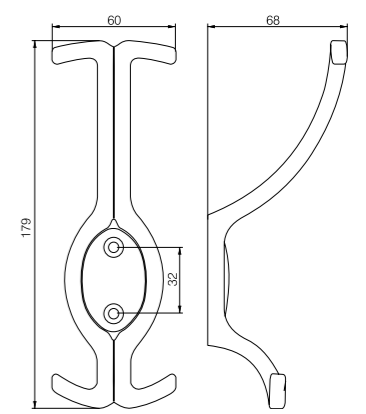

NOWOŚĆ

ZnAl G



A-1434

NOWOŚĆ



Z-5413

NOWOŚĆ

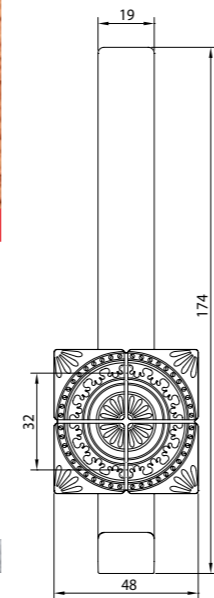
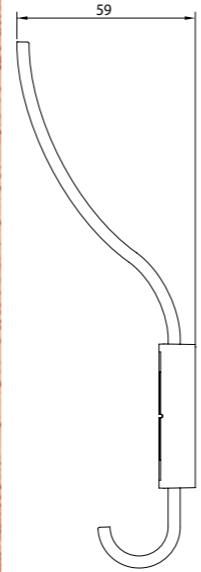

SPARTA	S	W	H	L	P
A-1434	38	23	38	100	
Z-5413	32	42	59	174	50
C-3264	128	38	23	155	25

ZnAl G4 G35

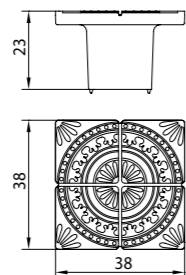

ZnAl G4 G35



NOWOŚĆ

C-3264

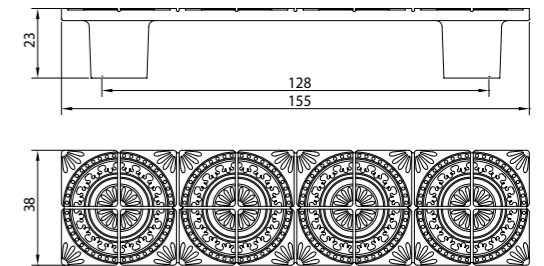

ZnAl G4 G35

B-080



B-100



E-370

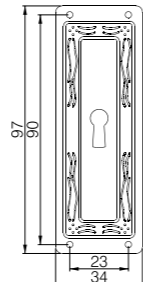
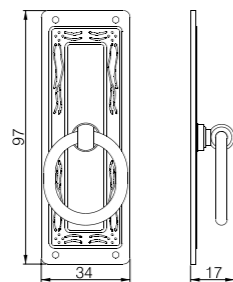

ZnAl

G

LEDA	S	W	H	L	P
B-080	34	17	97	50	
B-100	34	17	97	100	
E-370	34	3	97	100	
D-062	64	43	17	97	50

D-062

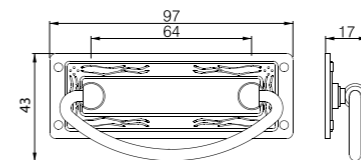



NOWOŚĆ

ZEUS	S	W	H	L	P
C-2943	96	22,5	24	150	50

ZnAl G

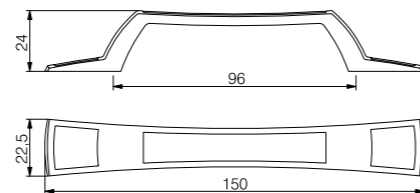

KRONOS	S	W	H	L	P
C-292	64	14	24	103	100
*C-293	96	14	24	135	100

ZnAl G



**Dieses Angebot gilt nicht für das Gebiet der Bundesrepublik Deutschland*

CLIO	S	W	H	L	P
C-1973	96	24	26	140	50

ZnAl G

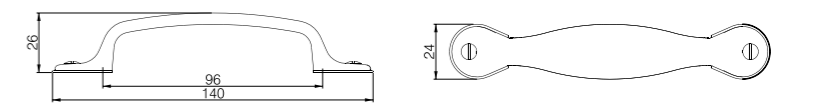



NOWOŚĆ

ANSA	S	W	H	L	P
C-3444	128	25	33	169	50

Plst ZnAl G2 G4 G5 G6

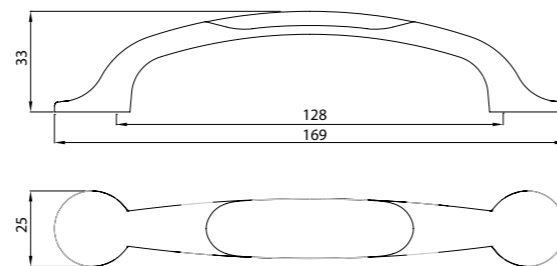

NOWOŚĆ

ERATO	S	W	H	L	P
C-3113	96	20	23	111	50

ZnAl G

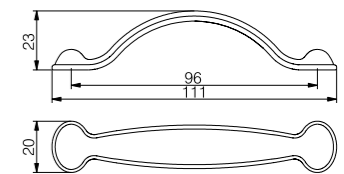

NYJA	S	W	H	L	P
C-1983	96	16	28	112	50

ZnAl G

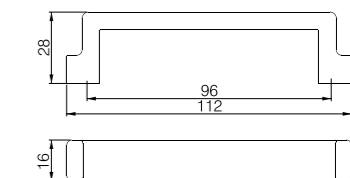



BACHUS	S	W	H	L	P
C-1003	96	15	29	111	100

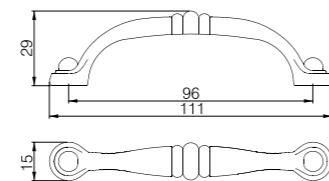

ZnAl G



CARMAN	S	W	H	L	P
C-1013 BP	96	24	25	108	100
C-1013 ZP	96	24	25	153	50

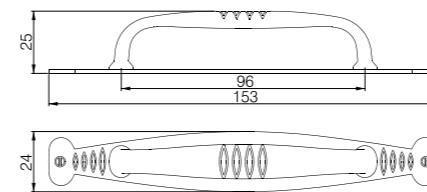

ZnAl G





CERBER S W H L P ZnAl G
C-1553 96 16 32 114 100

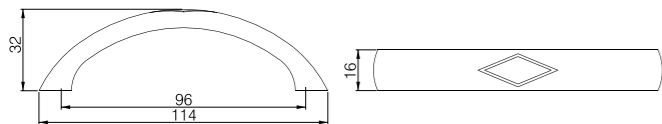

ASHEMA S W H L P ZnAl G
C-192 64 27 20 94 100

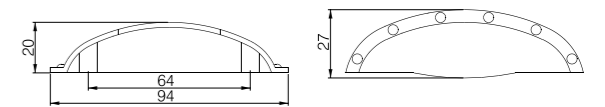

DAFNIS S W H L P ZnAl G
C-2062 64 28 23 93 100

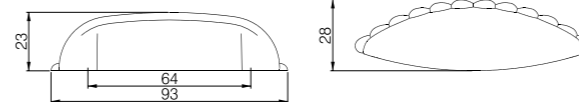

FORINUS	W	H	L	P
B-010	22	18	61	100

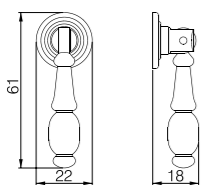

ZnAl G

OZYRYS	W	H	L	P
B-120	30	22	60	100

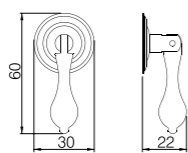

ZnAl G

SEDNA	W	H	L	P
B-700	15	23	57	200

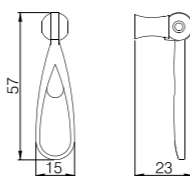

ZnAl G

GAJA	W	H	L	P
B-020	56	22	51	150

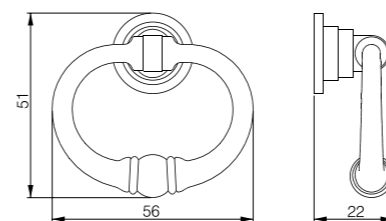

ZnAl G

GRYF	W	H	L	P
B-030	31	21	52	100

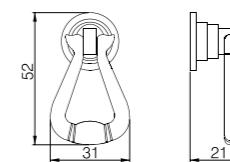

ZnAl G

TYTUS	W	H	L	P
B-040	39	17	46	100

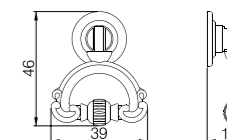

ZnAl G

IRYDA	W	H	L	P
B-050	40	18	52	100

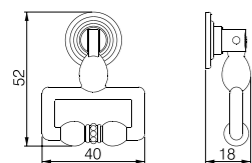

ZnAl G

KALIBE	W	H	L	P
B-060	27	16	50	200

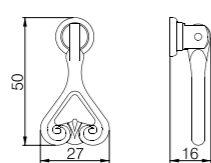

ZnAl G

HINO	W	H	L	P
B-070	35	16	55	200

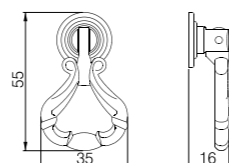

ZnAl G





DONAR	W	H	L	P
B-130	27	17	44	100

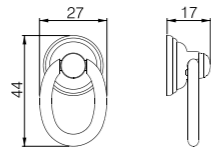

ZnAl G



MARS	W	H	L	P
B-090	63	17	51	100

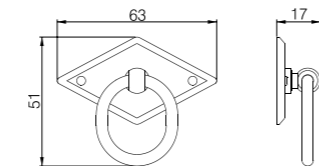

ZnAl G



PENELOPA	W	H	L	P
B-140	76	18	42	100

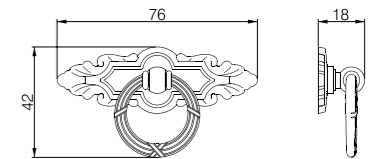

ZnAl G

KRODO	S	W	H	L	P
D-082	64	39	15	86	100

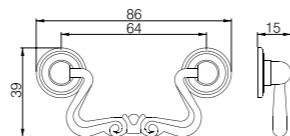

ZnAl G

TANTAL	S	W	H	L	P
D-088	80	39	15	102	150

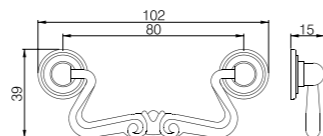

ZnAl G

URANOS	S	W	H	L	P
D-103	96	53	22	119	100

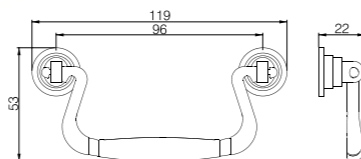

ZnAl G

VACUNA	S	W	H	L	P
D-108	80	49	21	103	100

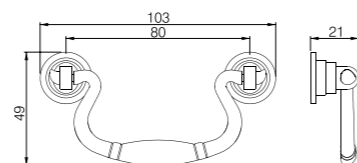

ZnAl G



PROWE	S	W	H	L	P
D-202	64	48	16	94	150

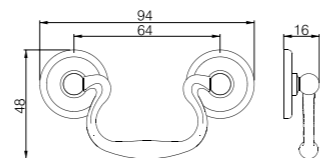

ZnAl G

ULYSSES	S	W	H	L	P
D-209	76	53	16	106	250

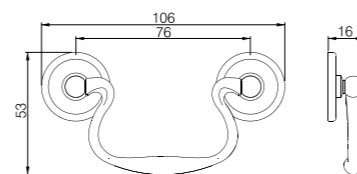

ZnAl G

ENEA	S	W	H	L	P
D-128	80	38	16	102	100

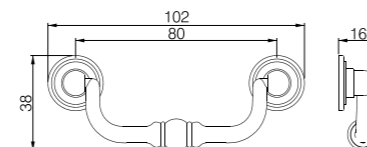

ZnAl G

RAHIM	S	W	H	L	P
D-023	96	41	18	119	150

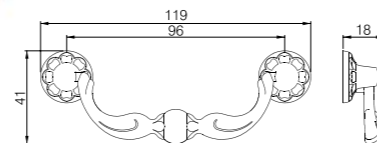

ZnAl G



VIRTUS	S	W	H	L	P
D-168	96	50	19	126	100

ZnAl G

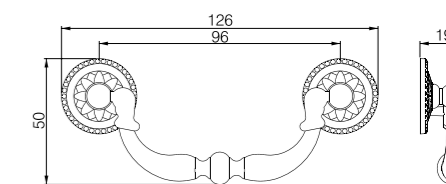



RENE	S	W	H	L	P
D-033	96	45	17	125	150

ZnAl G

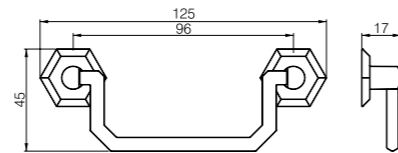

VICTA	S	W	H	L	P
D-133	96	42	15	118	100

ZnAl G

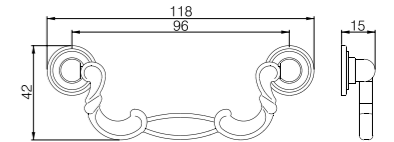

WALLI	S	W	H	L	P
D-193	96	47	18	118	100

ZnAl G

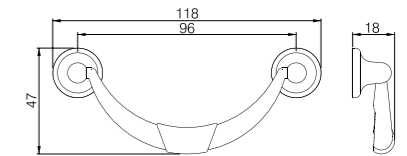

SATURN	S	W	H	L	P
D-052	64	48	20	86	100

ZnAl G

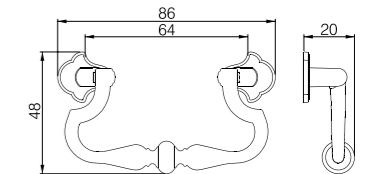

TEMIDA	S	W	H	L	P
D-098	80	31	19	91	100

ZnAl G

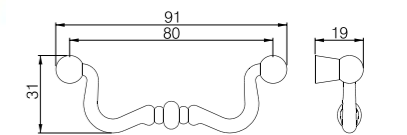



VALETA	S	W	H	L	P
D-119	68	45	16	90	100

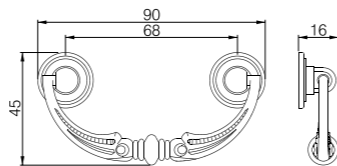

ZnAl G

VETIS	S	W	H	L	P
D-149	38	45	15	76	100

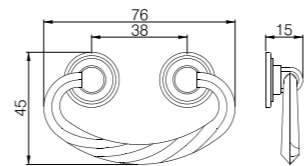

ZnAl G



SELENE	S	W	H	L	P
D-073	96	49	18	115	100

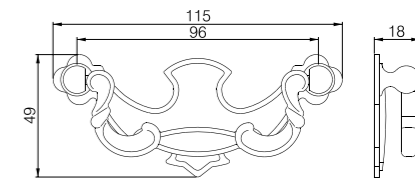

ZnAl G

HARPIA	W	H	P
E-330	13	21	200

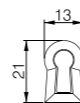

ZnAl G

MEDEA	W	H	P
E-340	23	30	100

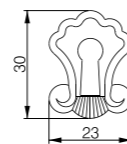

ZnAl G

AULOS	S	W	H	P
E-500	36	21	47	100

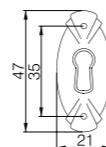

ZnAl G

NYKS	S	W	H	P
E-590	28	22	38	100

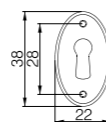

ZnAl G

ESCUDO	S	W	H	P
E-640	25	30	38	100

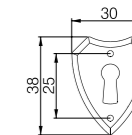

ZnAl G

KOYOS	S	W	H	P
E-610	37	21	46	100

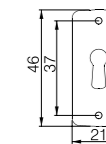

ZnAl G

ARGO	S	W	H	P
E-290	33	23	46	100

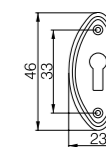

ZnAl G

CHIRON	S	W	H	P
E-310	32	26	46	100

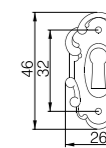

ZnAl G



TAWA	S	W	H	P
E-430	44	63	34	100
E-440	44	34	63	100



E-430

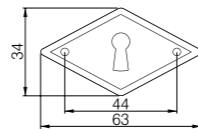

E-440

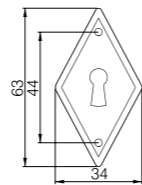

ZnAl G

ADONIS	S	W	H	P
E-550	52	31	91	100

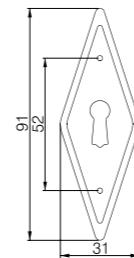

ZnAl G

PHINEUS	S	W	H	P
E-360	64	22	80	100

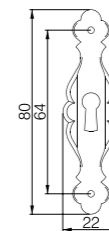

ZnAl G

DIANA	S	W	H	P
E-400	64	20	83	100

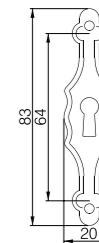

ZnAl G



E-410

FAUN	S	W	H	P
E-410	64	33	92	100
E-420	64	92	33	100

ZnAl G



E-420

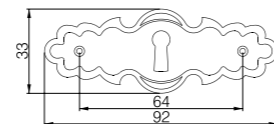
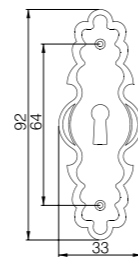

E-300

SFINKS	S	W	H	P
E-300	48	29	75	100
E-320	48	75	29	100

ZnAl G



E-320

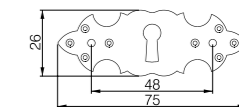
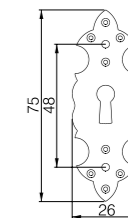

TEZEUS	S	W	H	P
E-510	67	22	80	100

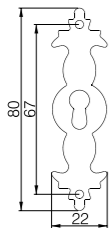

ZnAl G

THEBY	S	W	H	P
E-470	81	22	131	100

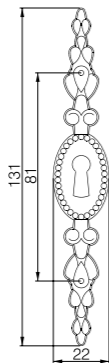

ZnAl G

TEJA	S	W	H	P
E-660	116	17	124	100

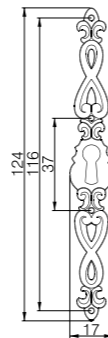

ZnAl G





TROYA	W	L	P
E-151	32	73	100

ZnAl G

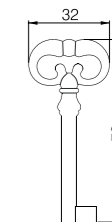

HOMER	W	L	P
E-161	35	75	100

ZnAl G



TELEMACH	W	L	P
E-171	29	76	100

ZnAl G

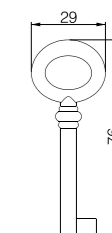

ILLIADA	W	L	P
E-191	35	70	100

ZnAl G

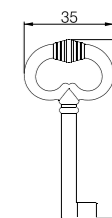

TYR	W	L	P
E-201	31	81	100

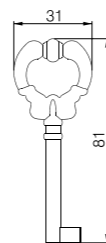

ZnAl G

MOIRA	W	L	P
E-211	32	71	100

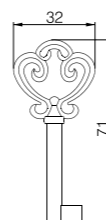

ZnAl G

NORNA	W	L	P
E-221	33	72	100

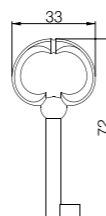

ZnAl G

ASTRATE	W	L	P
E-231	33	74	100

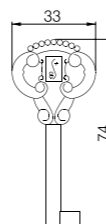

ZnAl G

NIOBE	W	L	P
E-241	30	71	100

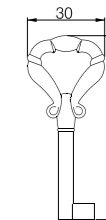

ZnAl G

SELU	W	L	P
E-251	28	70	100

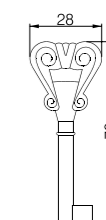

ZnAl G



MYTH	W	L	P
E-252	28	54	100

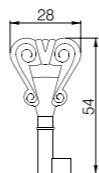

ZnAl G

PROCLUS	W	L	P
E-261	29	69	100

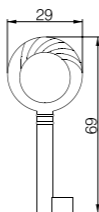

ZnAl G

LUNAR	W	L	P
E-271	35	70	100



ZnAl G

JASON	W	L	P
E-281	27	65	100

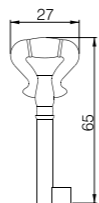

ZnAl G





FYOBE	Ø	W	L	P
G-310	8	31	81	100

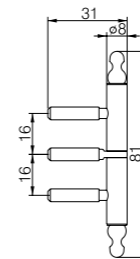

St G

ORFEUS	Ø	W	L	P
G-320	10	31	140	50

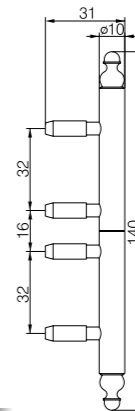

St G

PALLADA	Ø	W	L	P
G-341	8	46	78	100
G-342	8	46	78	100

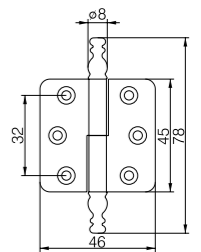

St G

zawiasy składane lewy – G-341, prawy – G-342
 folding hinges left – G-341, right – G-342
 петля мебельная левая – G-341, правая – G-342

HYDRA	S	W	H	L	P
Z-401	28	34	29	61	200
Z-402	38	51	32	74	100

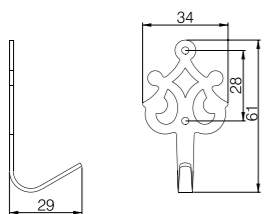

St G



MAJA	S	W	H	L	P
Z-415	32	72	72	165	100

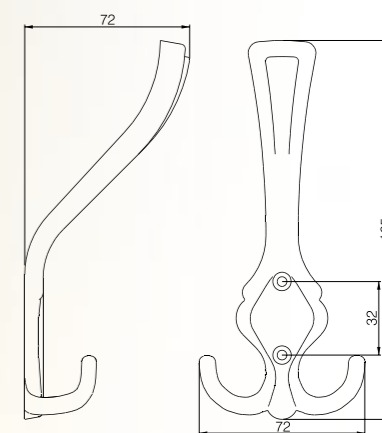

ZnAl G



AGAWE	S	W	H	L	P
Z-5403	37	51	86	125	100

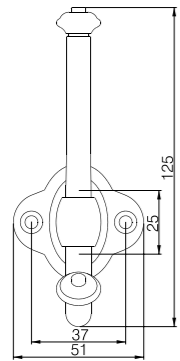
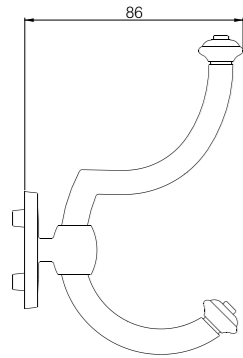

ZnAl G



ZnAl G

SOL	S	W	H	L	P
Z-5401	23	72	82	191	50
Z-5402	23	41	31	65	50



Z-5401

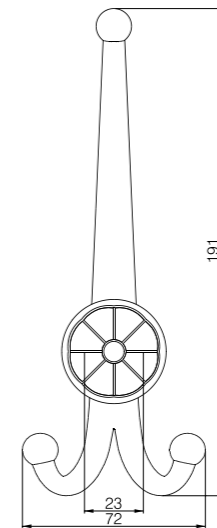
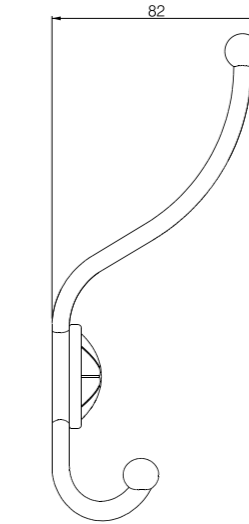

Z-5402

